

KENWOOD

A-7S

COMPUTER CONTROLLED STEREO INTEGRATED AMPLIFIER

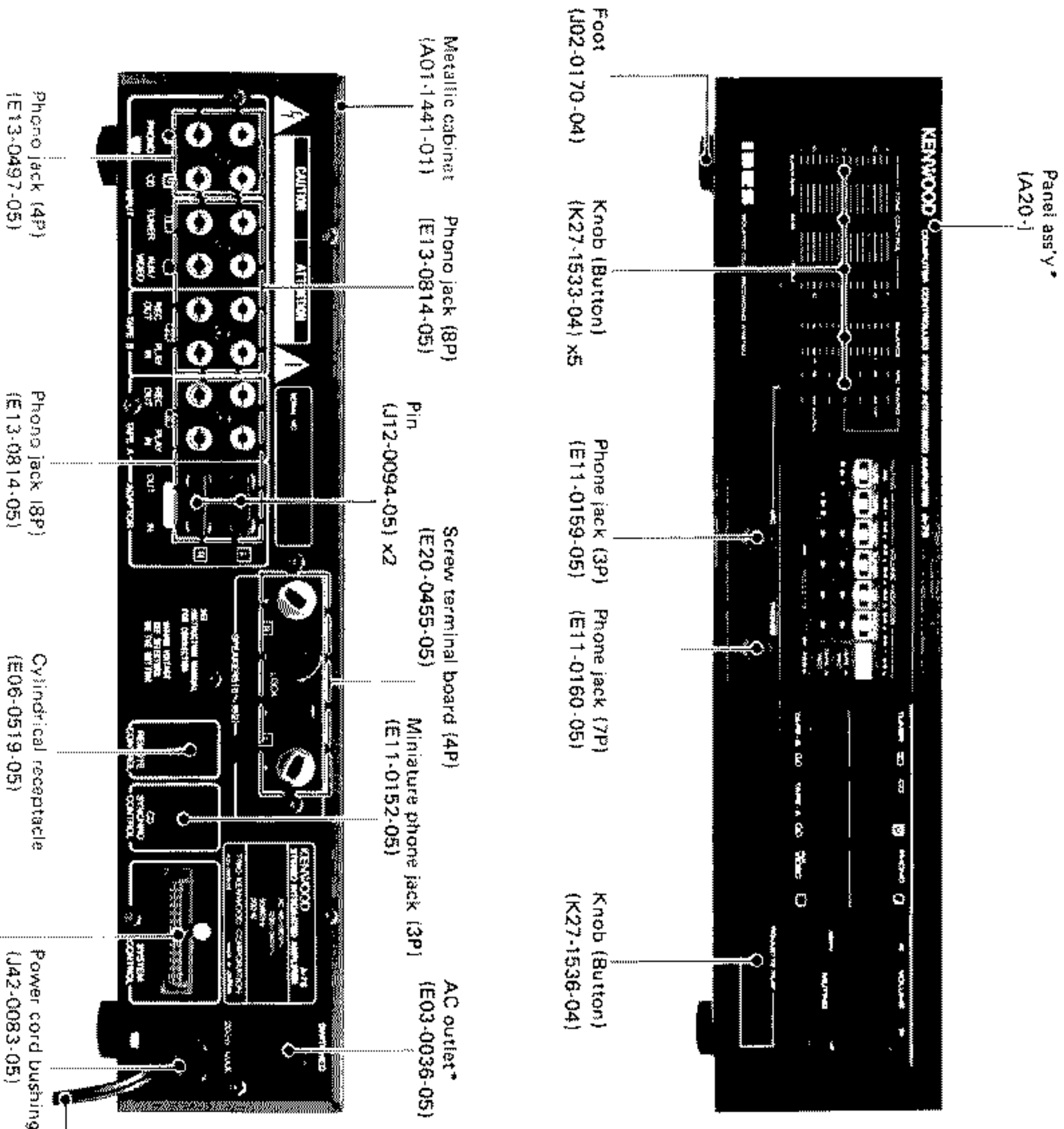

Caution When a repair to MIDI M-5S, MIDI M-7S is requested, be sure to advise the customer to ship together with amplifier A-7S. See precautions for repair on back cover.

*Refer to parts list on page 24.

CIRCUIT DESCRIPTION

3. Operation of system

A system of MIDI series does not operated correctly, unless all of the amplifier, tuner, and cassette deck are prepared. If only the amplifier or the combination of amplifier and tuner are prepared, the power can be turned on (the power for signal system), but it cannot be turned off unless the power cable is not disconnected.

The following table shows the voltage at each terminal of the system control connecting cable and its purpose.

Pin No.	Terminal voltage and signal name	When power cable is connected to outlet (X) and when power switch of tuner is turned on (★)			P-7S Indications
		A-7S Use	A-7S Indications	T-5S Use	
1	+5V (μ-COM)	★	MODE IND. TAPE A/B REC. ON VOL. IND. "1" ON	★	ARM DISPLAY IND. LED: ON (Illuminated)
2	DATA line				
3	BUSY line				
4	GND (DECK)				
5	GND (TUNER)				
6	GND (PLAYER)				
7	AC 4.7V (TUNER PL)			★	"00.00" blinking
8	AC 4.7V (TUNER FL)			★	FL: Frequency indication "00:00" blinking
9	+35V (TUNER VCC)	★		★	FL: Frequency indication
10	-35V (TUNER FL)				
11	+18V (DECK OUT)	★			
12	-15V (PLAYER MOTOR)	★			
13	+15V (Common power supply and PLAYER MOTOR)	★	DIRECTION LED ON (Illuminated)	★	LED ON For control

Table 3-1 The contents of Table 3-1 are shown as System Operation I and II in Fig. 3-1.

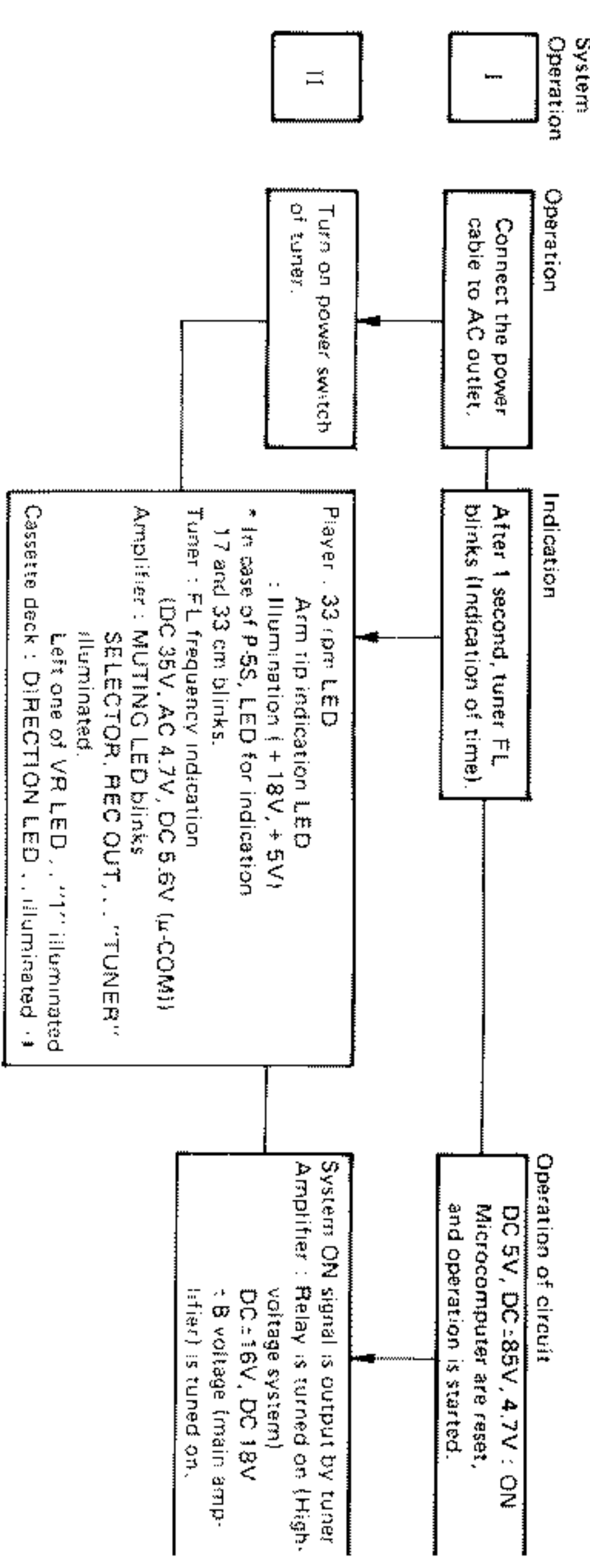

Fig. 3-1

Note: The tuner keeps the music selection memory and ON/OFF condition of the power (for about three days) after the power cable is disconnected. Therefore, when the power cable is connected to an AC outlet again, if the former conditions are still stored, the system start System Operation II immediately.

DISASSEMBLY FOR REPAIR

REMOVING THE PC BOARD (X09-2202-71)

- Pressing the pawls of the front panel which are securing the PC board in the directions of arrows, remove the PC board (1).

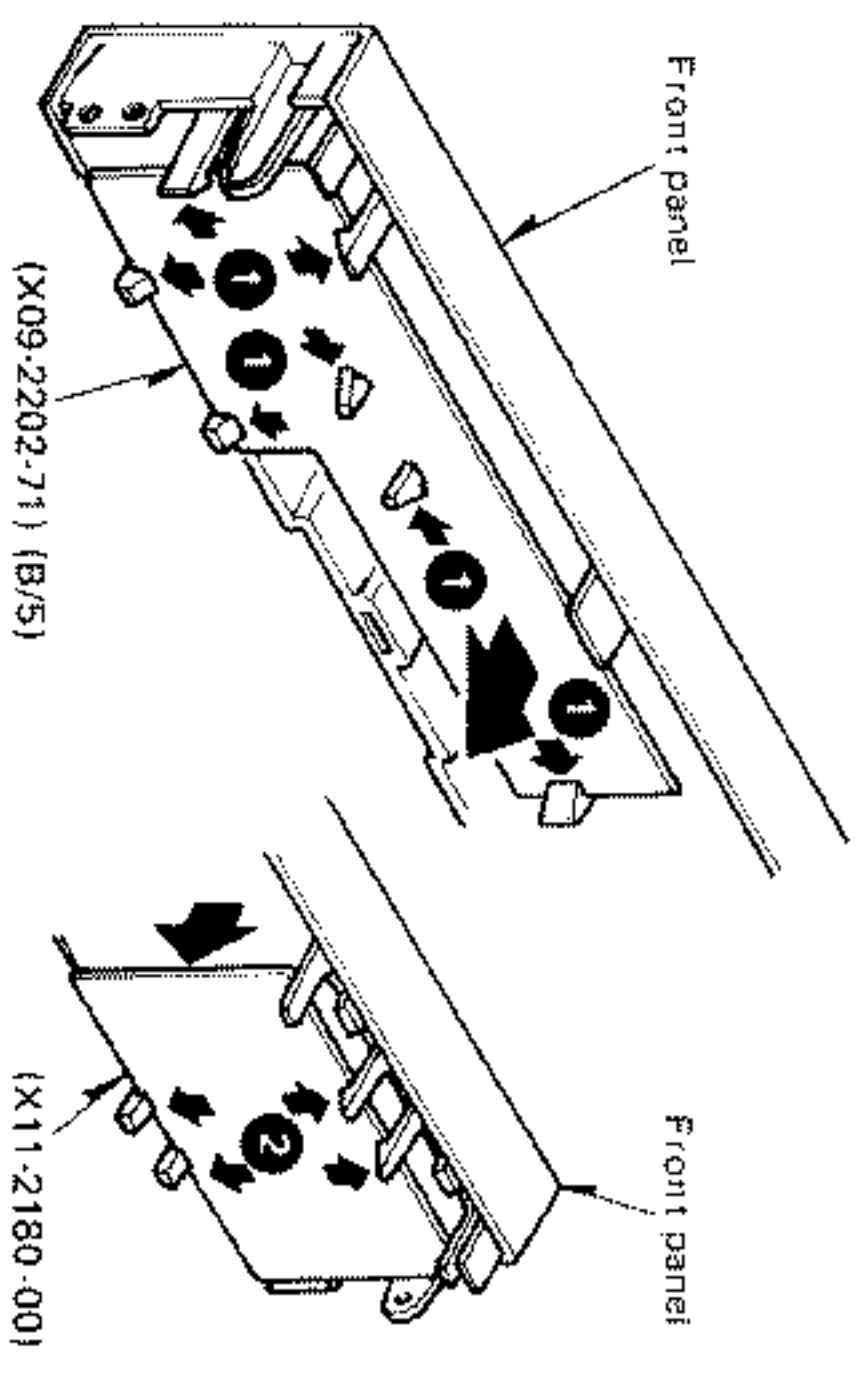

REMOVING AND REINSTALLING THE TONE UNIT (X11-2180-00)

- Pressing the pawls of the front panel which are securing the PC board in the directions of arrows, remove the PC board (2).
 - When reinstalling the PC board, lower each knob on the panel side to the lowest position (3), and move the shaft of each slide variable resistor to the position of the corresponding knob (4). Press the PC board horizontally from the rear of the panel so that the pawls will catch it (5).
- After reinstalling the PC board, confirm that the shafts of all the slide potentiometers are fixed to the knobs.

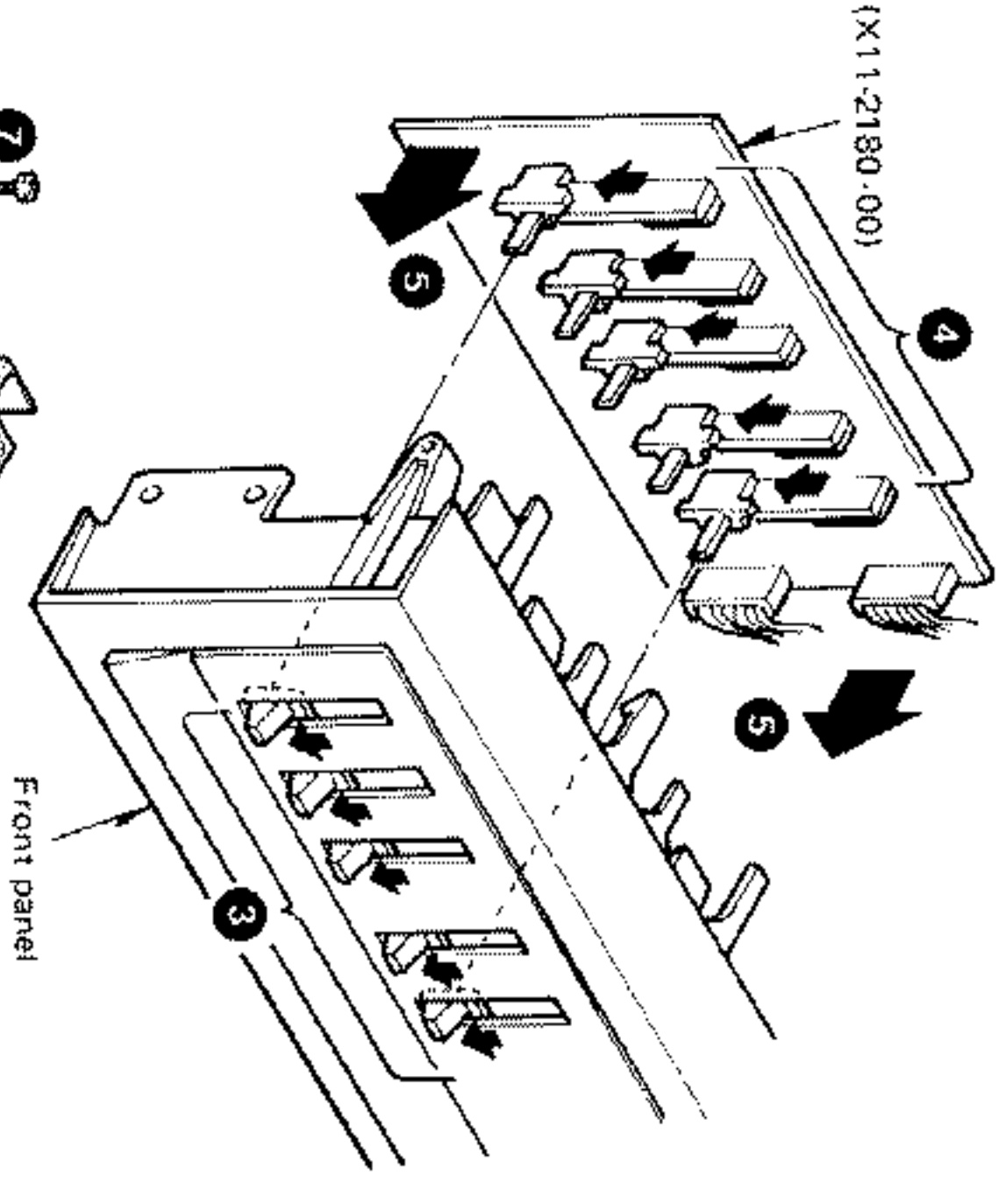

REMOVING THE POWER SUPPLY

- Remove the two screws from the rear side to remove the speaker terminal unit (6).
- Remove the two screws from the top of the power supply (7).
- Remove the two screws from the bottom plate which are securing the heat sink (8).
- Remove the two screws from the rear panel (9).
- Lift the power supply paying attention to the pawls of the heat sink (10).

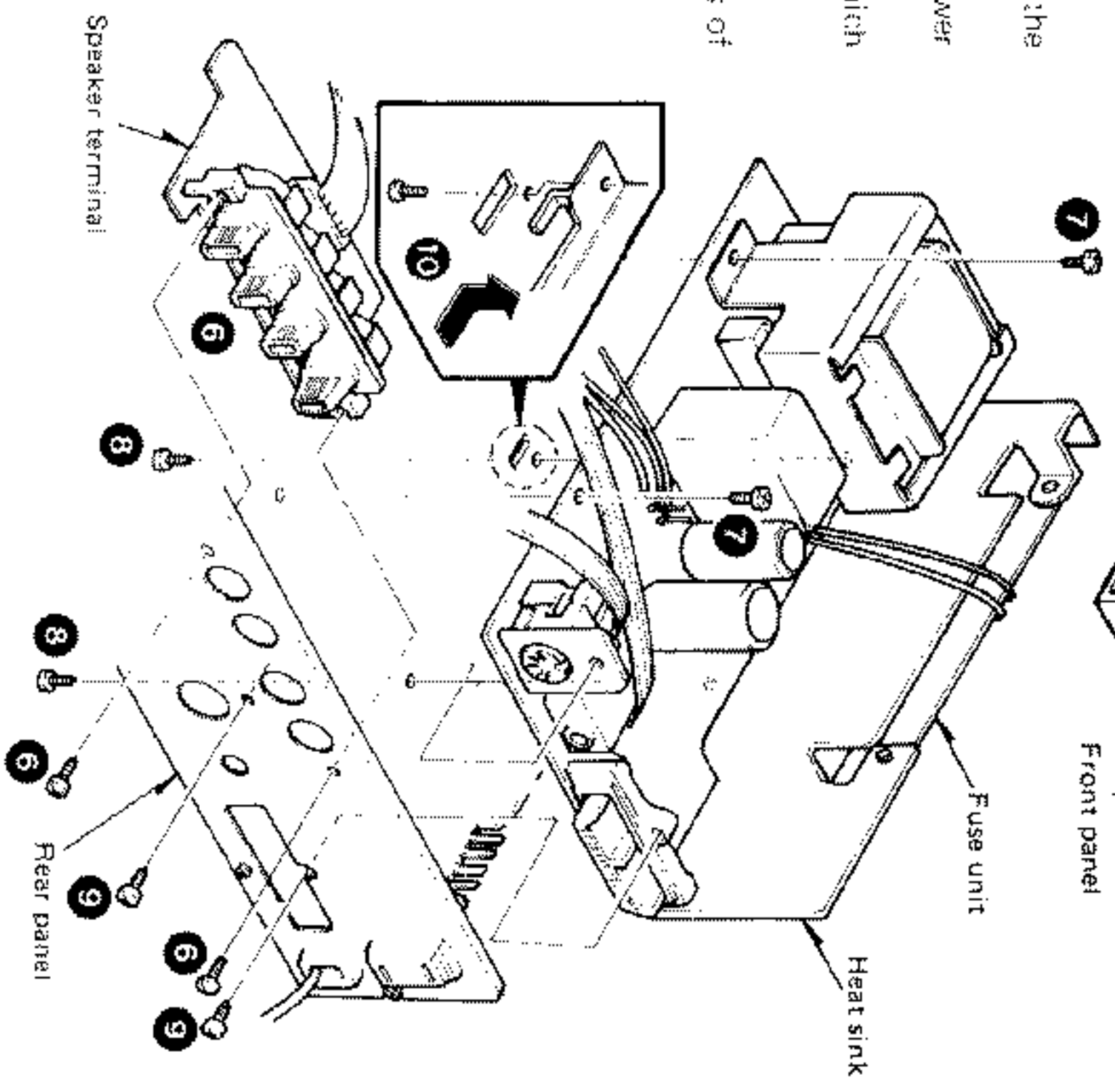

BLOCK DIAGRAM

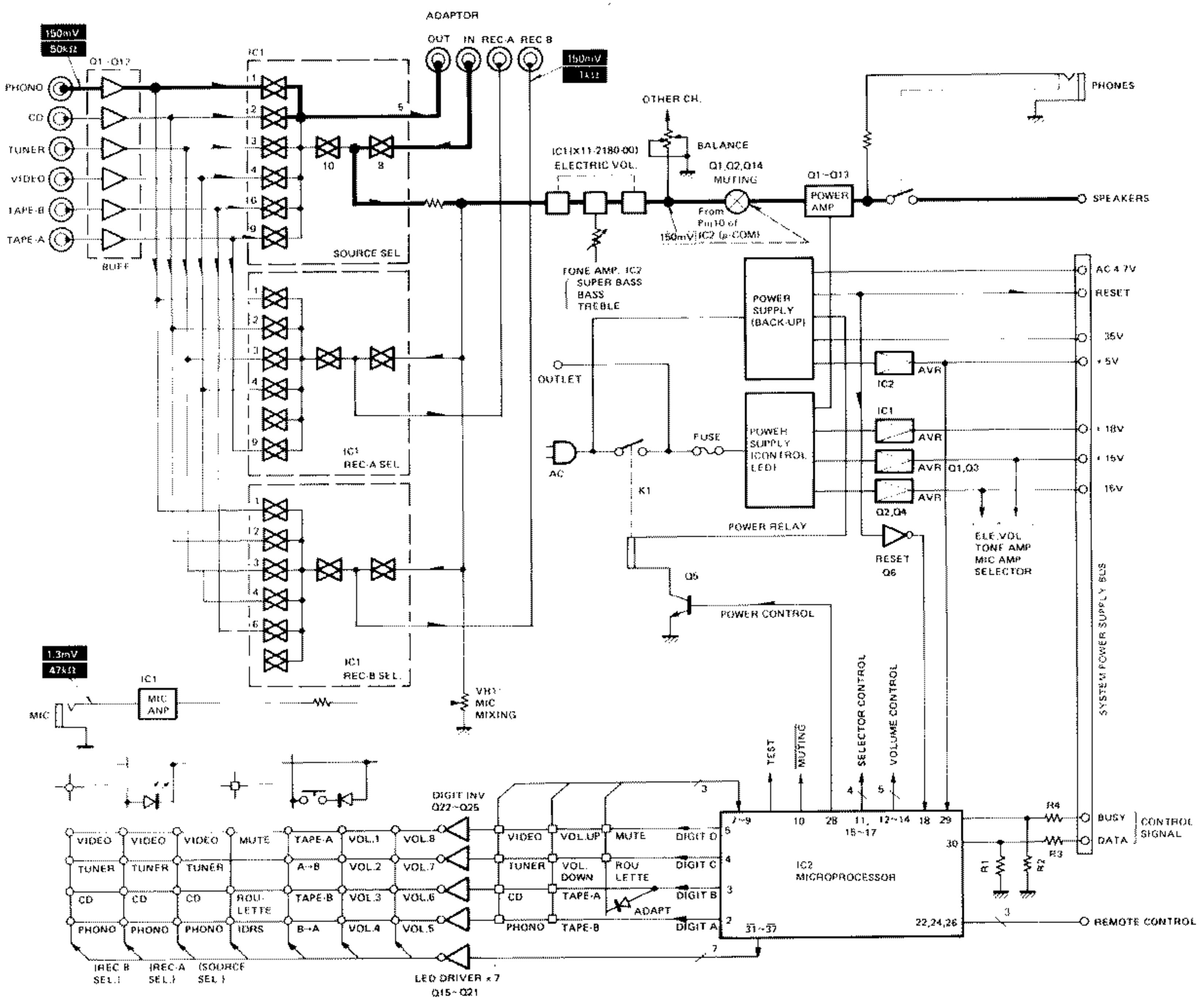

CIRCUIT DESCRIPTION

CIRCUIT DESCRIPTION

Description of components

POWER SUPPLY (X00-2362-71)

Components	Use and function	Operation/Condition/Interchangeability
Q1	Constant voltage power supply	Power supply of +18V. Supplies the power to the preamp for amplifier and the motor and buffer circuits of the cassette deck and turntable.
Q2	Constant voltage power supply	Power supply of -18V. Supplies the power to the preamplifier amplifier and the motor of turntable and the audio section of the tuner.
Q3,Q4	Constant voltage	Driver of Q1 and Q2.
Q5	For driving the power supply relay	Drives the relay with the output of microprocessor.
Q6	For resetting the microprocessor	The microprocessor is kept turned on as long as it is plugged in. HI signal is output to the microprocessor when it is plugged in and out.
IC1	Constant voltage	3-terminal regulator for +18V. Used for the signal systems of cassette deck and tuner.
IC2	Constant voltage	3-terminal regulator for +5V. Power supply for the microprocessors of all the systems except for the CD player and graphic equalizer.

AUDIO (X09-2202-71)

Components	Use and function	Operation/Condition/Interchangeability
Q1,Q2	Muting	Operates at the following times: When the selector is changed over. When volume control is set to minimum.
Q3,Q4	Compensating the bias current	
Q5~Q8	Driver	
Q9~Q12	Final (60W)	
Q13	Constant voltage power supply for class A	Prevents the shock noises made when the power is turned on and off with the slow attack or fast release.
Q14	Inverter for muting	
Q15~Q21	Driver of LED	Inverts the output of microprocessor and drives LED.
Q22~Q25	Inverter for DIGIT	Inverts the DIGIT signal of microprocessor and drives LED with Q15~Q21 LED is divided into four, and they are turned on alternately at intervals of about 25ms.
IC1	Microphone amplifier	
IC2	Microprocessor	Performs the following processes: <ul style="list-style-type: none"> Receives remote control signals from outside and convert them into serial data for communication. Performs communication among devices of MIDI series. Controls the selector. Controls the electronic volume control. Controls the power supply relay. Controls the muting transistors (Q1 and Q2).

PHONE (X11-2180-00)

Components	Use and function	Operation/Condition/Interchangeability
IC1	Electronic volume control	Receives the serial data from microprocessor and controls the sound volume. This IC performs -20dB muting, too.
IC2	Tone amplifier	3-stage circuit of output composition type. Interced between ATT1 and ATT2 of the electronic volume control, and used as a buffer amplifier, too.

SUB (X13-5192-70)

Components	Use and function	Operation/Condition/Interchangeability
Q1~Q12	3-stage amplifier	3-stage stage amplifier of emitter follower type. Prevents the shock noises made when changing to REC/DIT/PAIRS by the impedance conversion.

Microcomputer IC2 (μPD7508HC-049) : X09-2202-71

Terminal connection diagram (TOP VIEW)

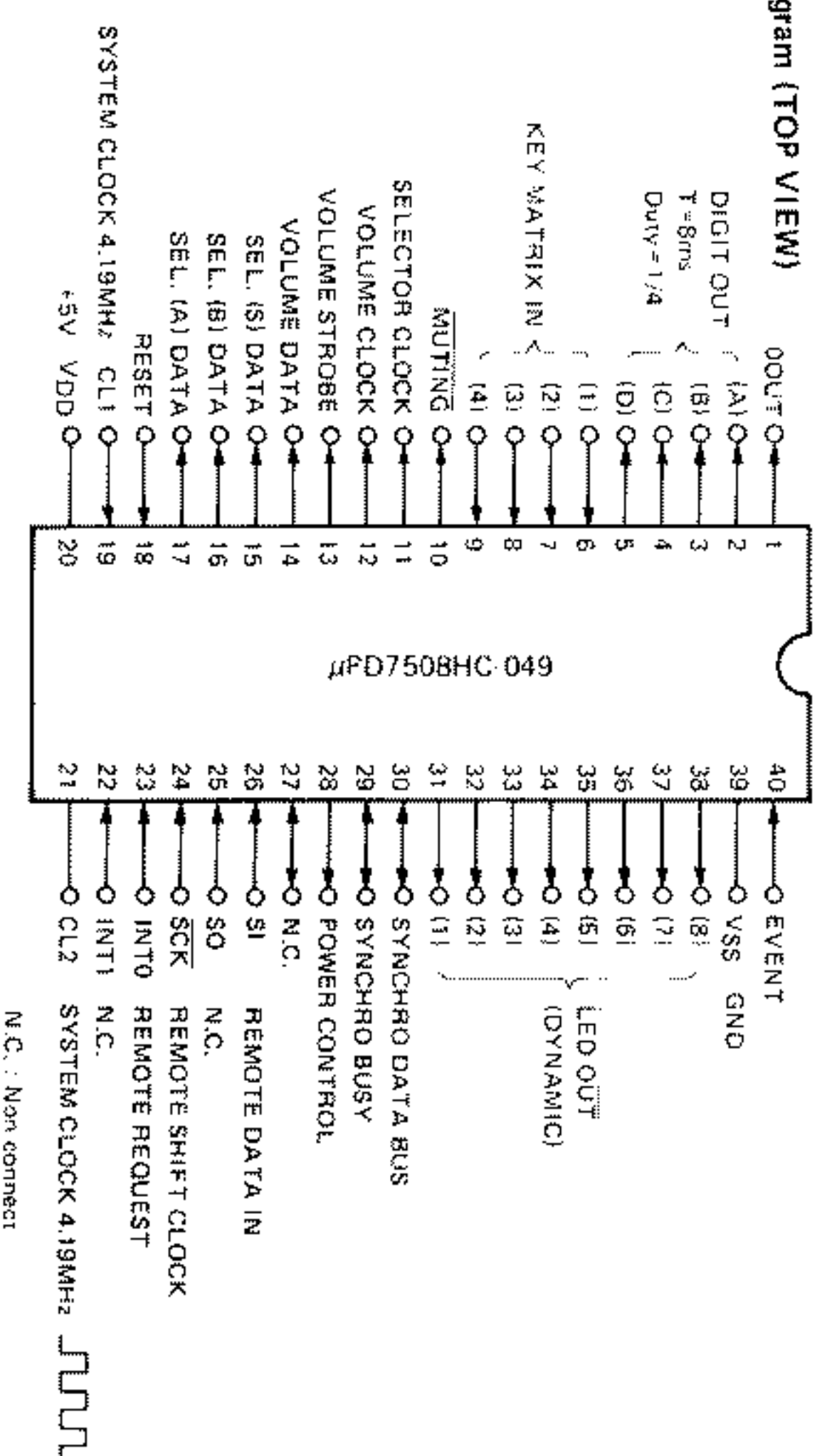

Specifications of ports

Terminal No.	Terminal name and use	I/O	Input/Output condition
1	0 OUT : Unused		
2~5	DIGIT OUT (A)~(D)	O	Approx. 2msec. when turned on. Approx. 6msec. when turned off. Active at "H". Duty ratio: 1/4
6~9	KEY MTX. (1)~(4)	I	Receives inputs together with DIGIT OUT. Active at "H". "H" 4.5sec after system power is turned on, and "L" just before the power is turned off. However, "L" when the selector is changed or volume control is minimized.
10	MUTING	O	
11	SEL. CLK.	O	Clock for driving the selector IC. Outputs only during operation.
12	VOL. CLK.	O	Clock for driving the electronic volume control IC. Outputs only during operation.
13	VOL. ST.	O	Strobe output for the electronic volume IC. For the detail, see "Electronic volume, IC TTC9176P" (page 01).
14	VOL. DATA	O	Serial data for the electronic volume IC. For the detail, see "Electronic Volume IC TTC9176P" (page 01).
15	SEL. S DATA	O	Serial data for SOURCE selector IC. Outputs only at time of changeover.
16	SEL. B DATA	O	Serial data for REC. OUT-B selector IC. Outputs only at time of changeover.
17	SEL. A DATA	O	Serial data for REC. OUT-A selector IC. Outputs only at time of changeover.
18	RESET	I	Inputs just after turning on and before turning off the main power. Set to the initial state.
19	CL1	I	System clock (4.19MHz)
20	VDD	I	+5V power supply
21	CL2	O	System clock (4.19MHz)
22	INT ⁺ : Unused		
23	PSHKY (INT0)	I	Interrupt input of remote control's pin.
24	SOCK	I	Clock input of remote control signal
25	SI (SDT)	I	Serial data input of remote control
26	PS0 : On ass		
27	PS1 : On ass		
28	PS2 : On ass		
29	PS3 : On ass		
30	IO DATA	I/O	Input/Output for easy operation communication. Output indicator signal.
31~34	DISP. MTX. I (1)~(4) : LED OUT I	O	Input/Output for easy operation communication. Data bus.
35~38	DISP. MTX. II (1)~(4) : LED OUT II	O	Outputs the indicator on signal together with DIGIT OUT. Active at "L".
39	VSS : GND		Outputs the indicator on signal together with DIGIT OUT. Active at "L".
40	EVENT : Unused		

CIRCUIT DESCRIPTION

CIRCUIT DESCRIPTION

Matrix table

Terminal name	DIGIT OUT (A) 2 pin	DIGIT OUT (B) 3 pin	DIGIT OUT (C) 4 pin	DIGIT OUT (D) 5 pin
Use	Condition	Use	Condition	Use
6 pin (Test pin ④) VOL. MAX.	Test pin ⑧	Test C VOL. MIN.	Test B All LED's are lit.	Test A System is turned on.
7 pin KEY MTKX. LOUDNESS	Turned on during "H".	ADAPTER	Turned on during "H".	ROULETTE
8 pin TAPE-B	Tact S8	TAPE-A	Tact S7	VOL. DOWN
9 pin PHONO	Tact S4	CD	Tact S3	TUNER
31 pin VOL. 5	-10dB level	VOL. 6	-10~-6dB	VOL. 7
32 pin VOL. 4	-20dB level	VOL. 3	-30dB level	VOL. 2
DISP. MTKX. I	TAPE-B → A (SEL. A)	D22	TAPE-B (SEL. S)	D21
34 pin L.D.R.	When SEL. I ~III are not the same	ROULETTE	Playing roulette	RANDOM
35 pin PHONO (SEL. S)	D29	CD (SEL. S)	D28	TUNER (SEL. S)
36 pin PHONO (SEL. A)	D33	CD (SEL. A)	D32	TUNER (SEL. A)
DISP. MTKX. II	PHONO (SEL. B)	D37	CD (SEL. B)	TUNER (SEL. B)
38 pin LOUDNESS	Loudness control is turned on.	ADAPTER	Adapter is turned on.	VIDEO (SEL. B)
				VIDEO (SEL. A)
				VIDEO (SEL. S)
				VIDEO (SEL. B)
				MUTE
				At time of -20dB damping
				D19
				D20
				D26
				D27
				D30
				D31
				D33
				D34
				D35
				D36
				D37
				D38
				D39
				D40
				D41
				D42
				D43
				D44
				D45
				D46
				D47
				D48
				D49
				D50
				D51
				D52
				D53
				D54
				D55
				D56
				D57
				D58
				D59
				D60
				D61
				D62
				D63
				D64
				D65
				D66
				D67
				D68
				D69
				D70
				D71
				D72
				D73
				D74
				D75
				D76
				D77
				D78
				D79
				D80
				D81
				D82
				D83
				D84
				D85
				D86
				D87
				D88
				D89
				D90
				D91
				D92
				D93
				D94
				D95
				D96
				D97
				D98
				D99
				D100

Note : The test mode will be explained later in detail. Switches and LED related to the above LOUDNESS, ADAPTER, and RANDOM are not installed to the set.

Input/Output operation

When resetting
If RESET is input when the main power is turned on and off, the following controls are set as shown at right of them.

- (a) SEL. S, A, B → TUNER
- (b) VOLUME → -50dB
- (c) MUTE (P53) → OFF
- (d) BLANCE → CENTER
- (e) IDR, ROULETTE, RANDOM → OFF
- (f) The same operation as that performed when MUTING (P30) → SYSTEM POWER ON:OFF

When turning on the system

If the SYSTEM ON signal for the synchro data is received from the tuner, the power control terminal (28) is raised and the power is supplied to the outside. After about 4.5 seconds, the muting function is turned off. However, the volume control data before the system is turned on is -∞, the muting function is not turned off.

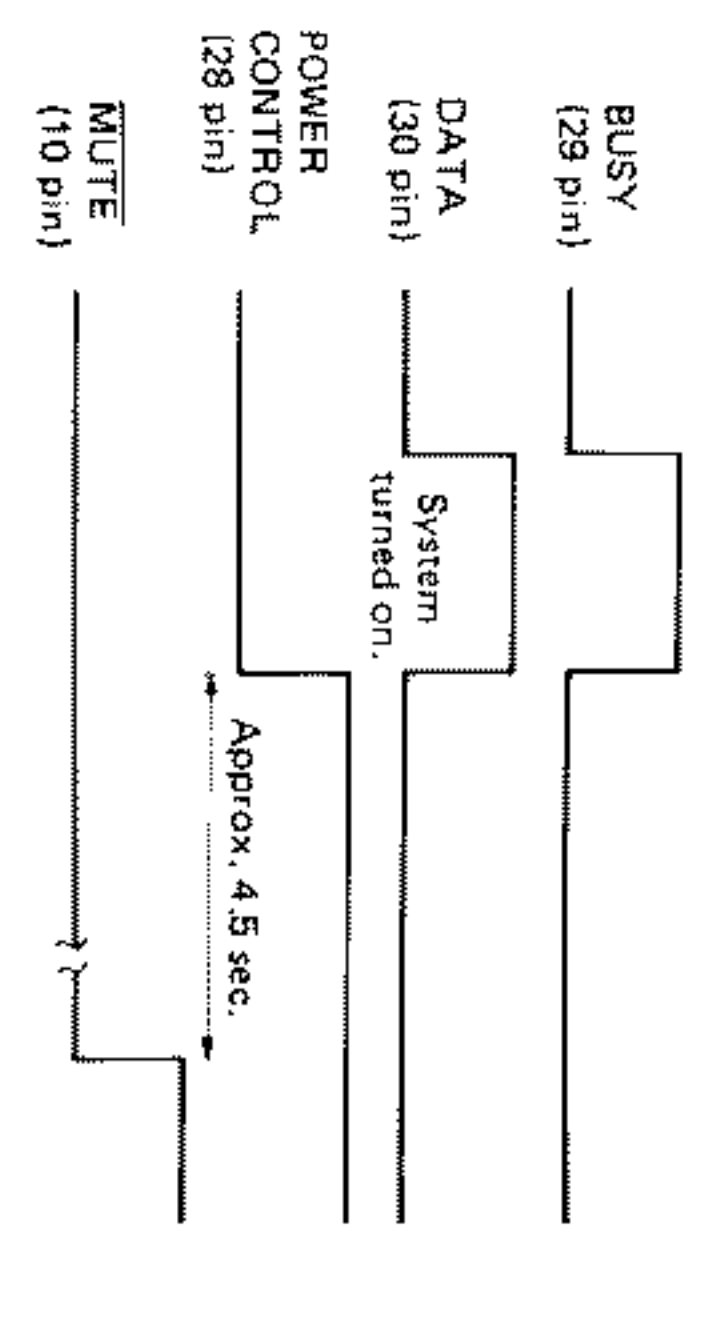

When turning off the system

If the SYSTEM OFF signal for the synchro data is received from the tuner, the muting function is turned on. In case a record player has been connected, the power control is turned off to cut off the power supplied to the outside when the OFF signals for both record player and cassette deck are received. In case the record player has not been connected, the same operation is performed when the OFF signal for the cassette deck is received.

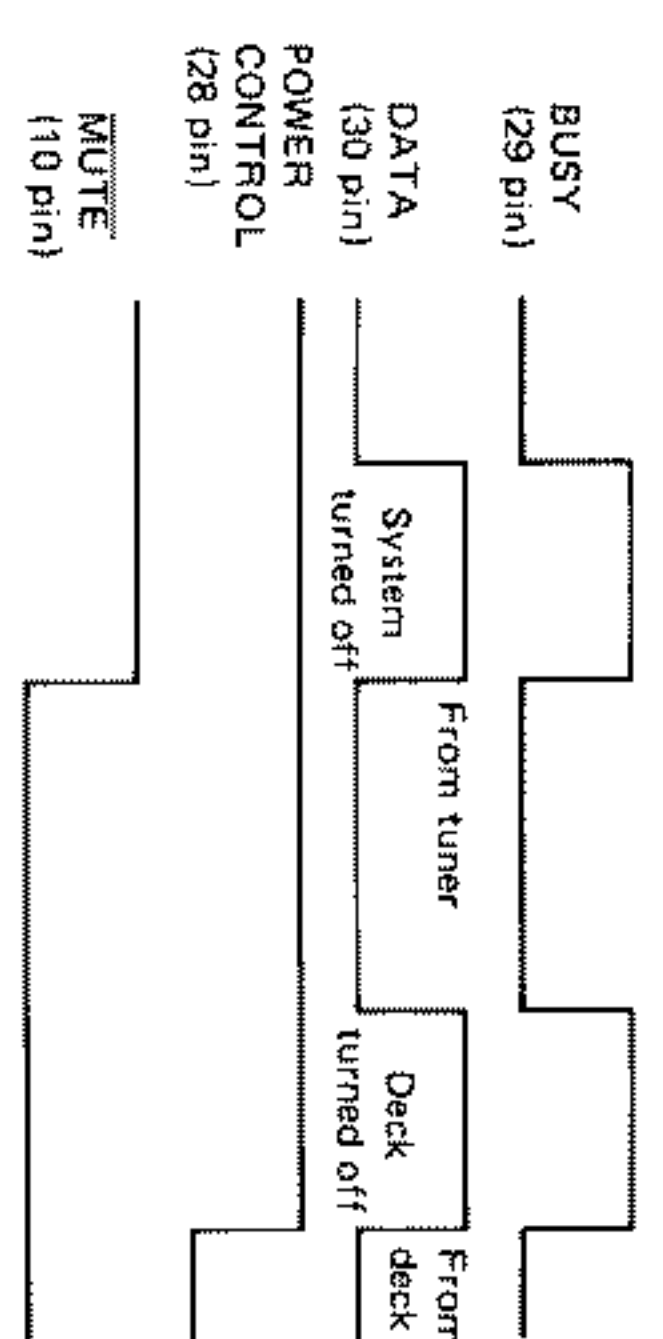

Test mode

Test pins ④, ⑤, ⑥, ⑦, and ⑧ on the circuit board correspond to ports 6, 5, 4, 3, and 2 of the microprocessor. The following test mode can be checked using each test pin. When performing the test, connect test pins ⑤ ~ ⑧ and ④ with diodes as shown in the figure at right. (Connect them so that ④ will be on the cathode side.)

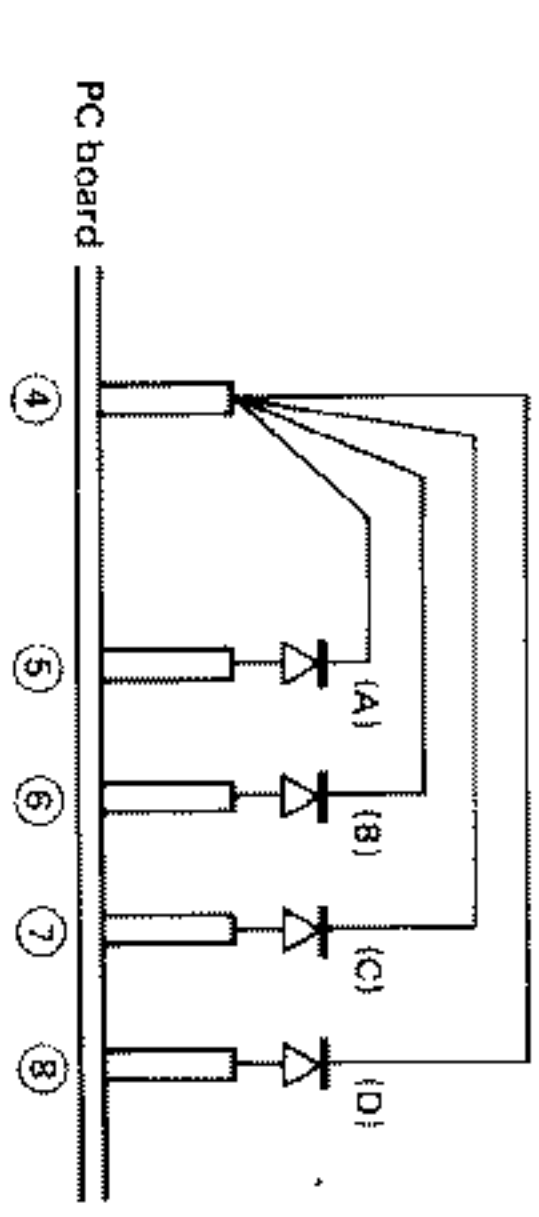

Test	Test pin	Short/Open	Operation
A	④ & ⑤	Short	The system is turned on. The muting function operates for about 4.5sec.
B	④ & ⑥	Short	All indicator LED's are lit.
C	④ & ⑦	Short	Kept in normal state.
D	④ & ⑧	Short	VOLUME is set to -∞ (MIN)
E	④ & ⑦ & ⑧	Short	VOLUME is set to 0dB (MAX)
		Open	No change.
		Open	VOLUME is set to -40dB.
		Open	No change.

Note : Tests B ~ E are effective while the system is turned on. Since A-7S is not equipped with the power switch, turn it on by itself by press the four keys of TUNER, CD, PHONO, MUTING switches. (However, it cannot be turned off by itself.)

CIRCUIT DESCRIPTION

CIRCUIT DESCRIPTION

Electronic volume IC1 (TC9176P) : X11-2180-00

Outline

TC9176P is an electronic volume control IC which can control the sound volume by inputting a serial data from the outside. With this IC, the sound volume can be set from 0dB to -76dB with steps of 2dB or can be set to any one of 40 steps between 0dB and -∞dB.

Terminal connection diagram (TOP VIEW)

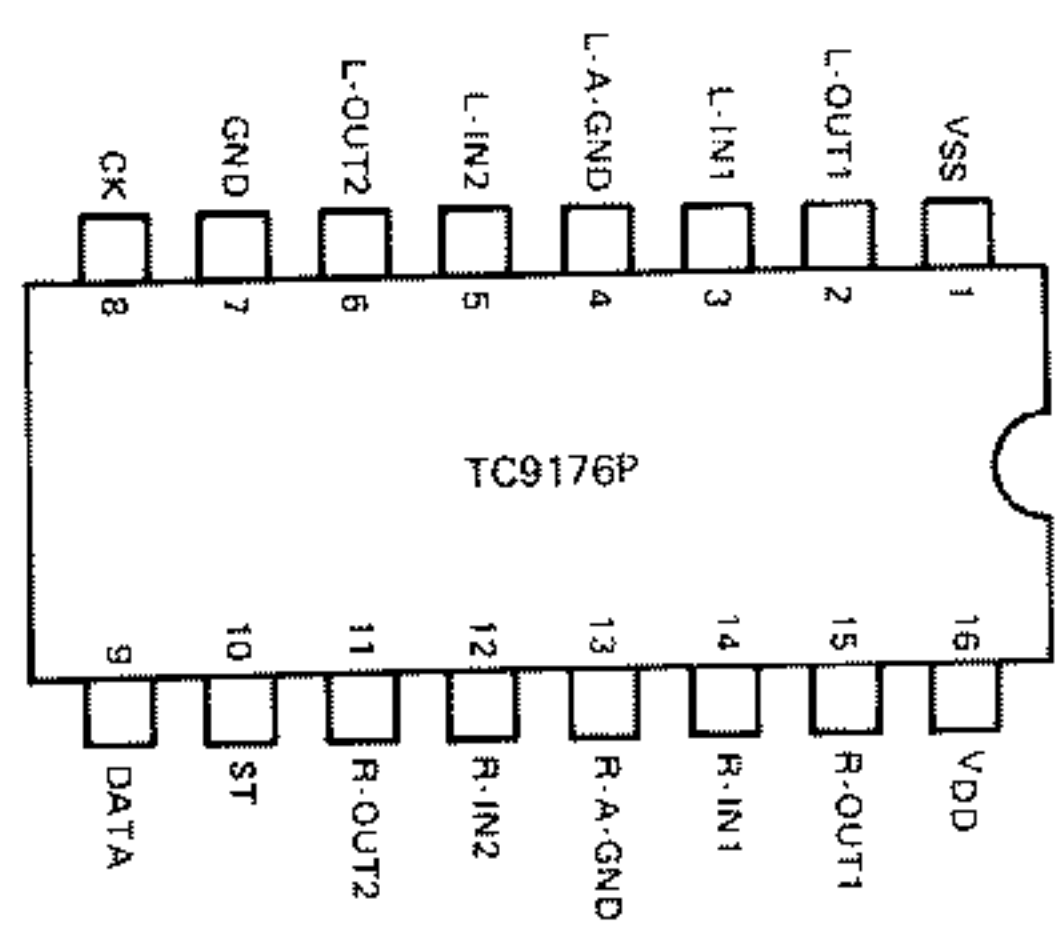

Functions of terminal

Terminal No.	Symbol	Functions	Remarks
2 (L) 15 (R)	L-OUT 1 R-OUT 1	10dB attenuator output terminal. Signals applied to IN are damped to one of eight levels between 0 and 70dB with 10dB step.	(L/R) 2/15
3 (L) 14 (R)	L-IN 1 R-IN 1	10dB attenuator input terminal.	3/14
4 (L) 13 (R)	A-GND	AC grounding terminal.	4/13
5 (L) 12 (R)	L-IN 2 R-IN 2	2dB step attenuator input terminal.	5/12
6 (L) 11 (R)	L-OUT 2 R-OUT 2	2dB step attenuator output terminal. Signals applied to IN are damped to one of five levels between 0~8dB with 2dB step.	6/11
9	DATA	Terminal for inputting data of damping level and channel selection. 20 bit CK signal is input through pin 14 (VOL. DATA) of microprocessor IC2. Clock input terminal for receiving the data of DATA terminal. The data is input through pin 12 (VOL. CLK) of microprocessor IC2.	Low-threshold value input inverter
8	CK	Strobe input terminal. The data of damping level and channel selection received from DATA and CK terminal are latched by setting this terminal to "H" level. If "H" level is not applied this terminal, the previous data are maintained. The data are input through pin 13 (VOL. ST) of microprocessor IC2.	
16	VDD	(+) power input terminal.	
7	GND	Grounding terminal.	
1	VSS	(-) power input terminal.	

Operation

Setting the damping level

The 20 bit data freely made is input through DATA, CK, and ST terminals to IC1 (TC9176P).
For example, if the data of (110010000001000000001) is input, the damping level is -22dB. Data bits 1 and 2 indicate the selection of Lch and Rch. Bits 4~8 are used to set the 2dB step attenuator and bits 9~16 are used to set

the 10dB step attenuator. Bits 17~20 are the tip select bits. When they are 100011, the selection is performed, and when not, the selection is not performed.
The damping to the infinite level is performed by inputting the data of -78dB. Therefore, the value one step higher than the infinite level is -76dB. The change of the received data is synchronized with the rise of ST signal.

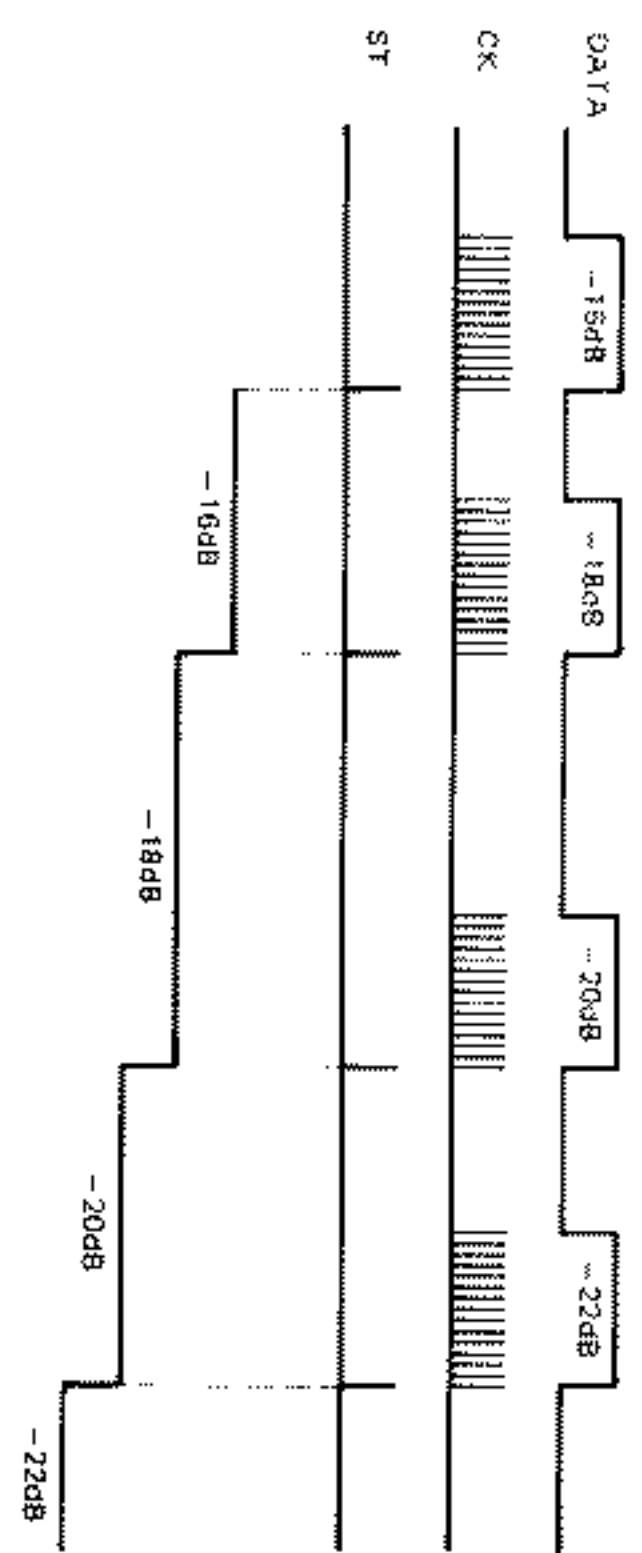
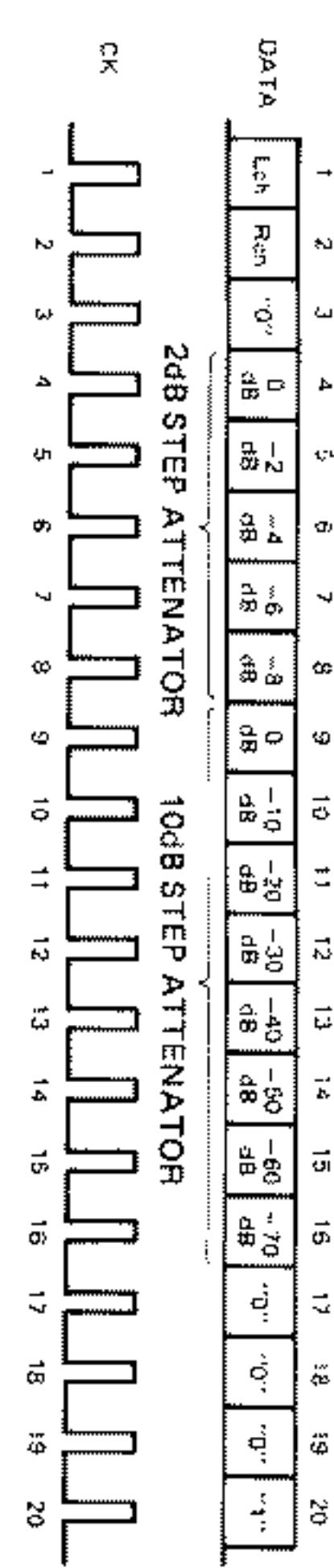

DATA, CK and ST input

IC1 (TC9176P) is driven by two power sources of (+) and (-). Since it has a level shifter, DATA, CK and ST are operated by (+) power source only. Since the input inverter of these three terminals lowers the input threshold value, they are operated at 5V logical level.

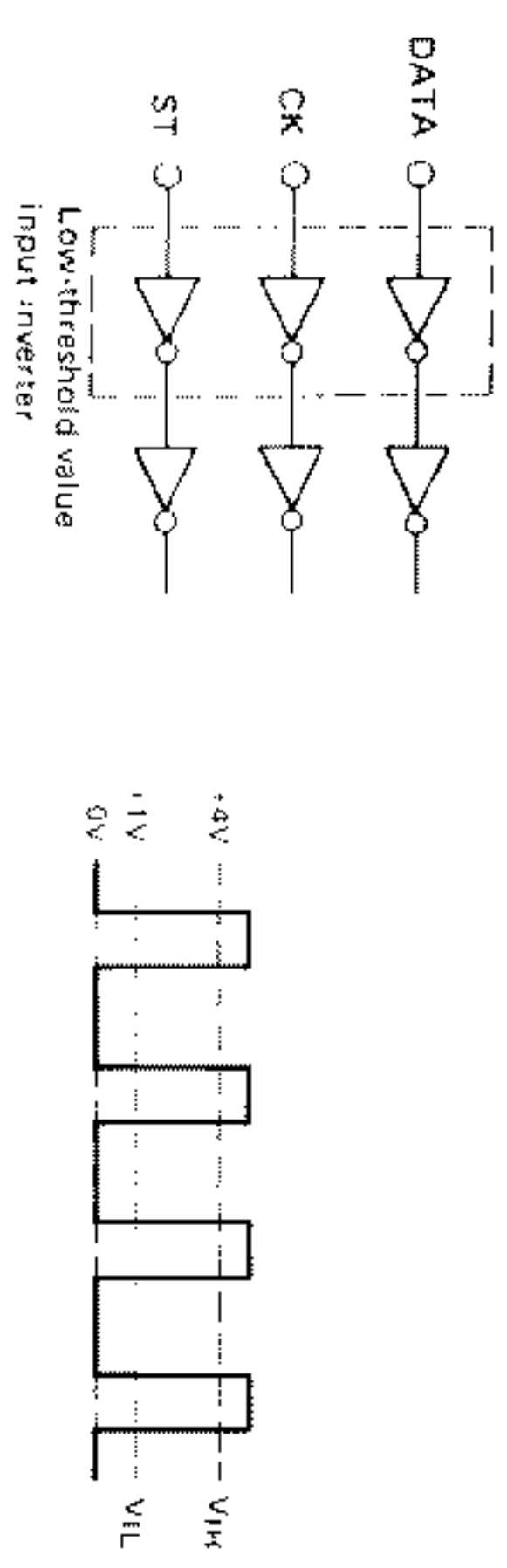

DATA, CK and ST are executed according to the following schedule:

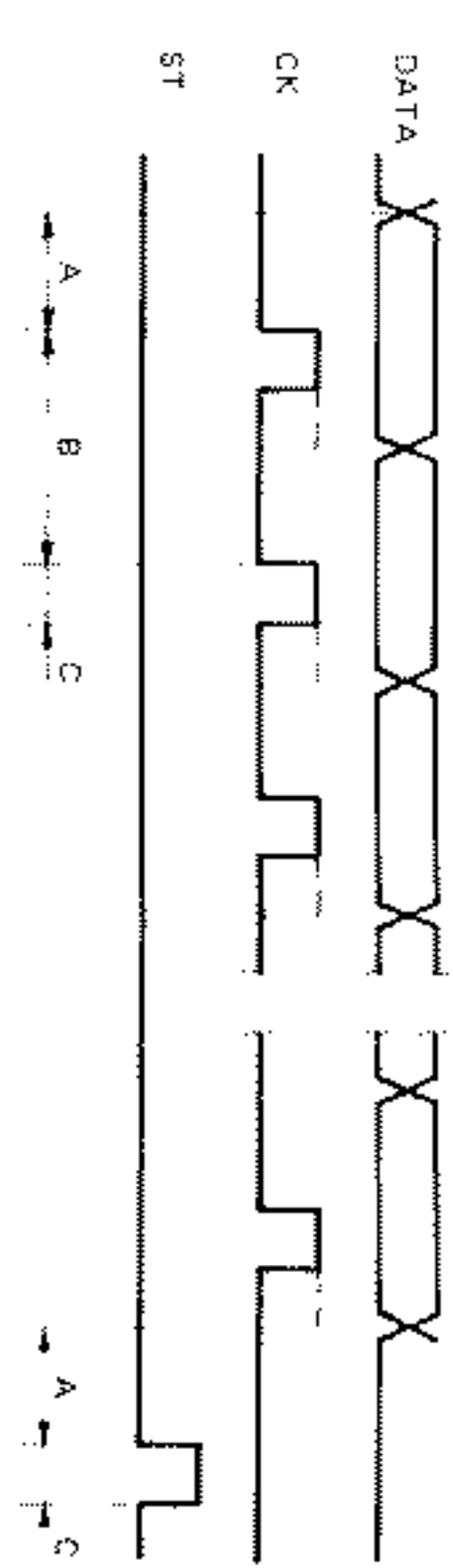

CIRCUIT DESCRIPTION

● **Attenuators**

Each attenuator is composed of the diffusion resistance array and analog switch. Attenuator 1 can damp to 0~70 dB with 10dB steps, and attenuator 2 can damp to 0~8dB with 2dB steps, thus they can damp to 0~76dB with 2dB steps.

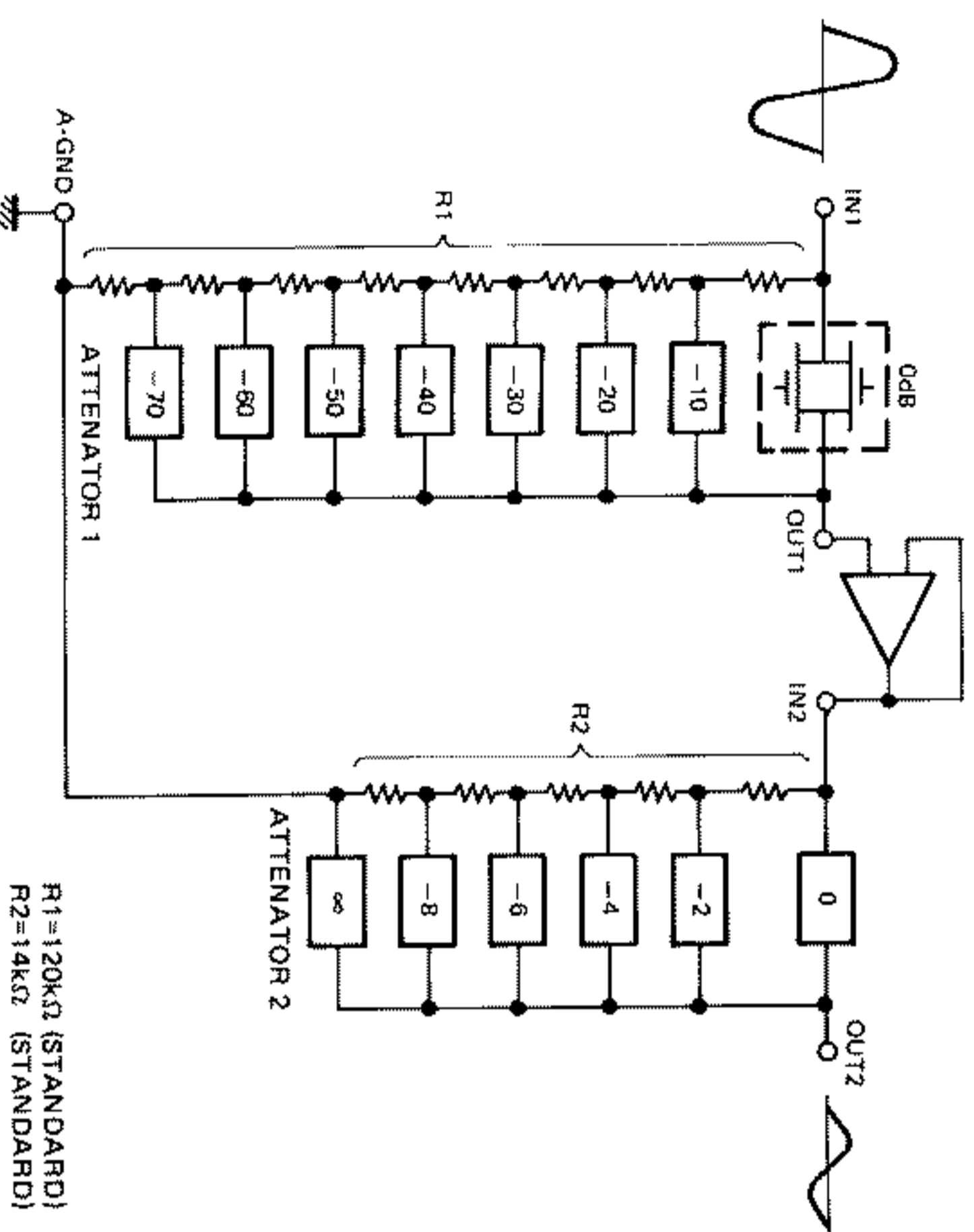

CIRCUIT DESCRIPTION

Easy operation system

1. EO (Easy operation system) of ROXY D series

Each component of MIDI series is controlled by transferring 8 bit serial data through two common digital signal lines (BUSY and DATA).

The data transfer function is installed to the amplifier (A-7S), cassette deck (X-7WS), tuner (T-5S/T-5LS), turntable (P-7S and P-5S), and CD player (DP-770).

● **System components connections**

The easy operation connection of each component of MIDI series is realized with the system control connecting cable. This cable is composed of six types of power lines (BUSY/DATA). The six types of power lines are used to collect the power from all the power supply circuits to the amplifier A-7S and supply the power from the amplifier to

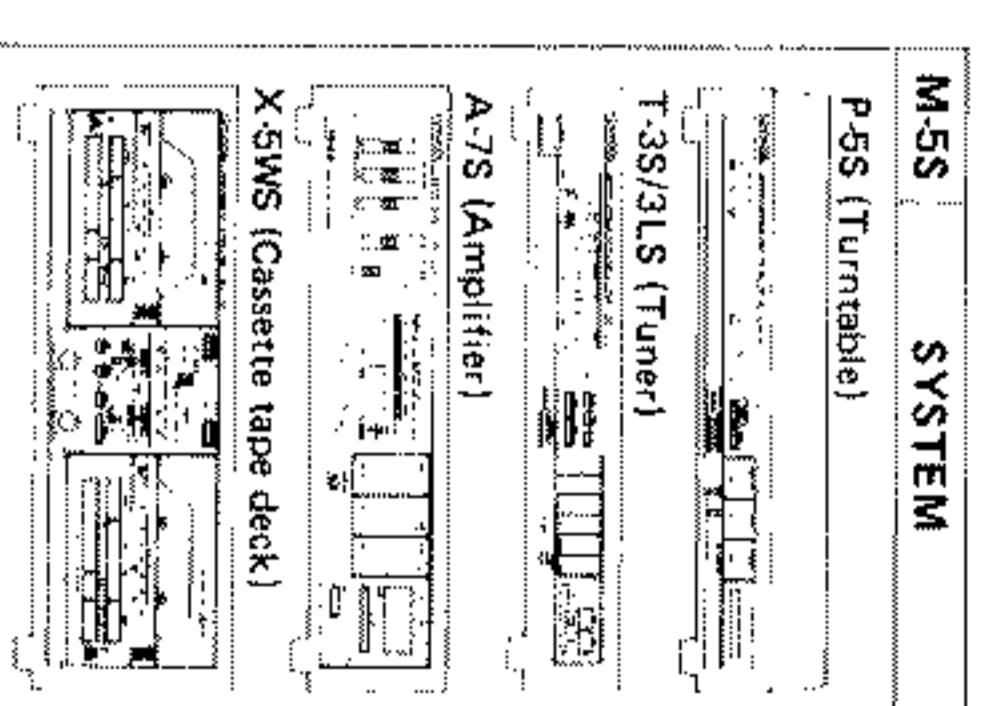
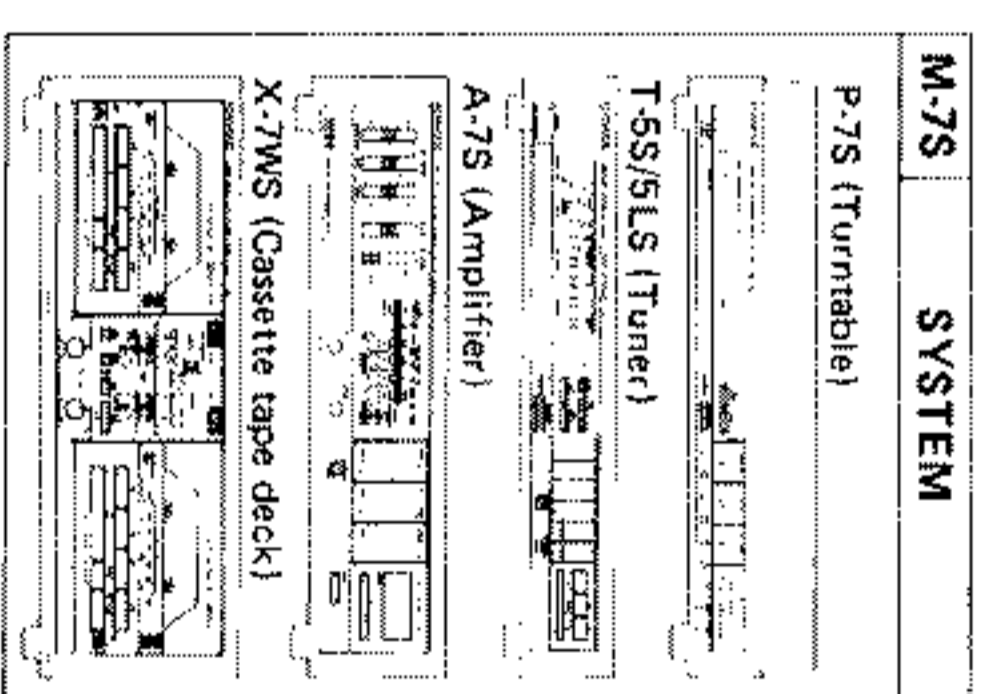

each component. Necessary lines are selected from these ones and connected to the components (See Fig. 1-5~1-9). The two digital signal lines are used to perform the easy operation with the BUSY/DATA signals.

In the former MIDI system, the easy operation signals were sent and received between the amplifier and tuner, between the amplifier and cassette deck, and between the amplifier and record player through the respective synchro cable. However, in MIDI series, the microprocessors in the components connected to one another through the two digital signal lines (BUSY/DATA) contained in the system control connecting cable, and the information concerning the easy operation is carried by means of 8 bit serial transfer.

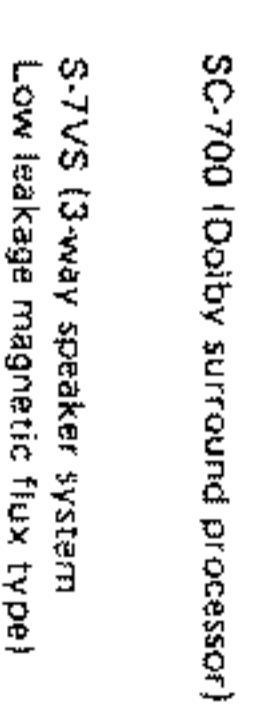
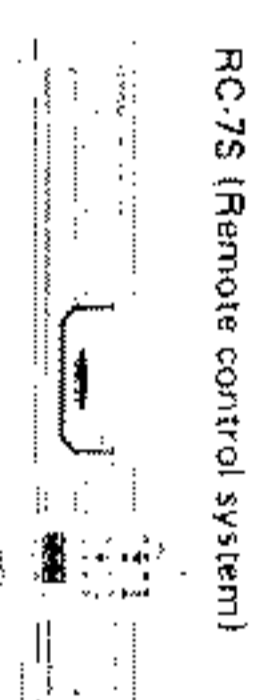
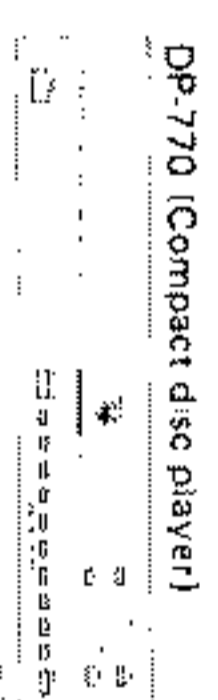

Fig. 1-1

CIRCUIT DESCRIPTION

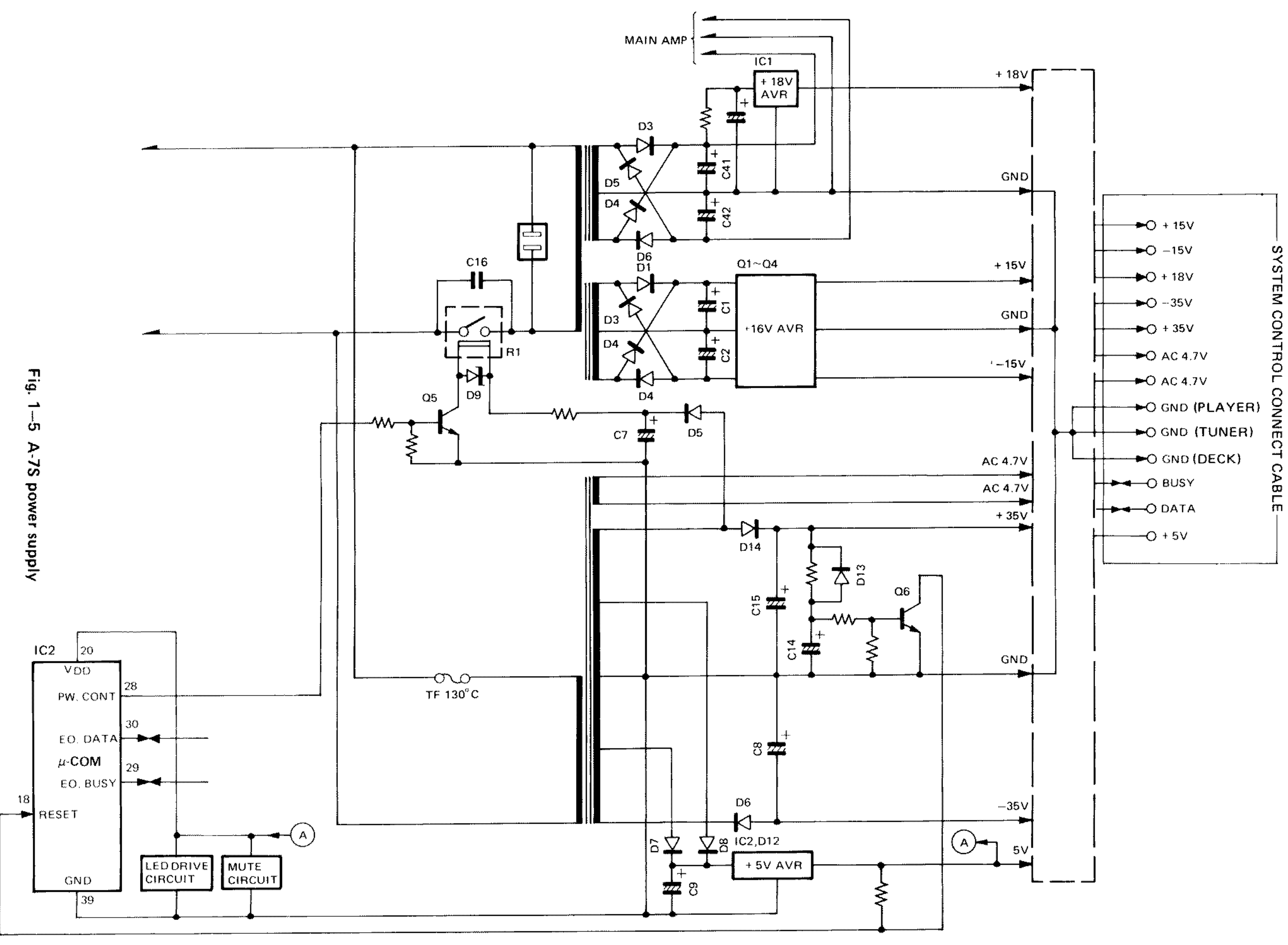

Fig. 1-5 A-7S power supply

CIRCUIT DESCRIPTION

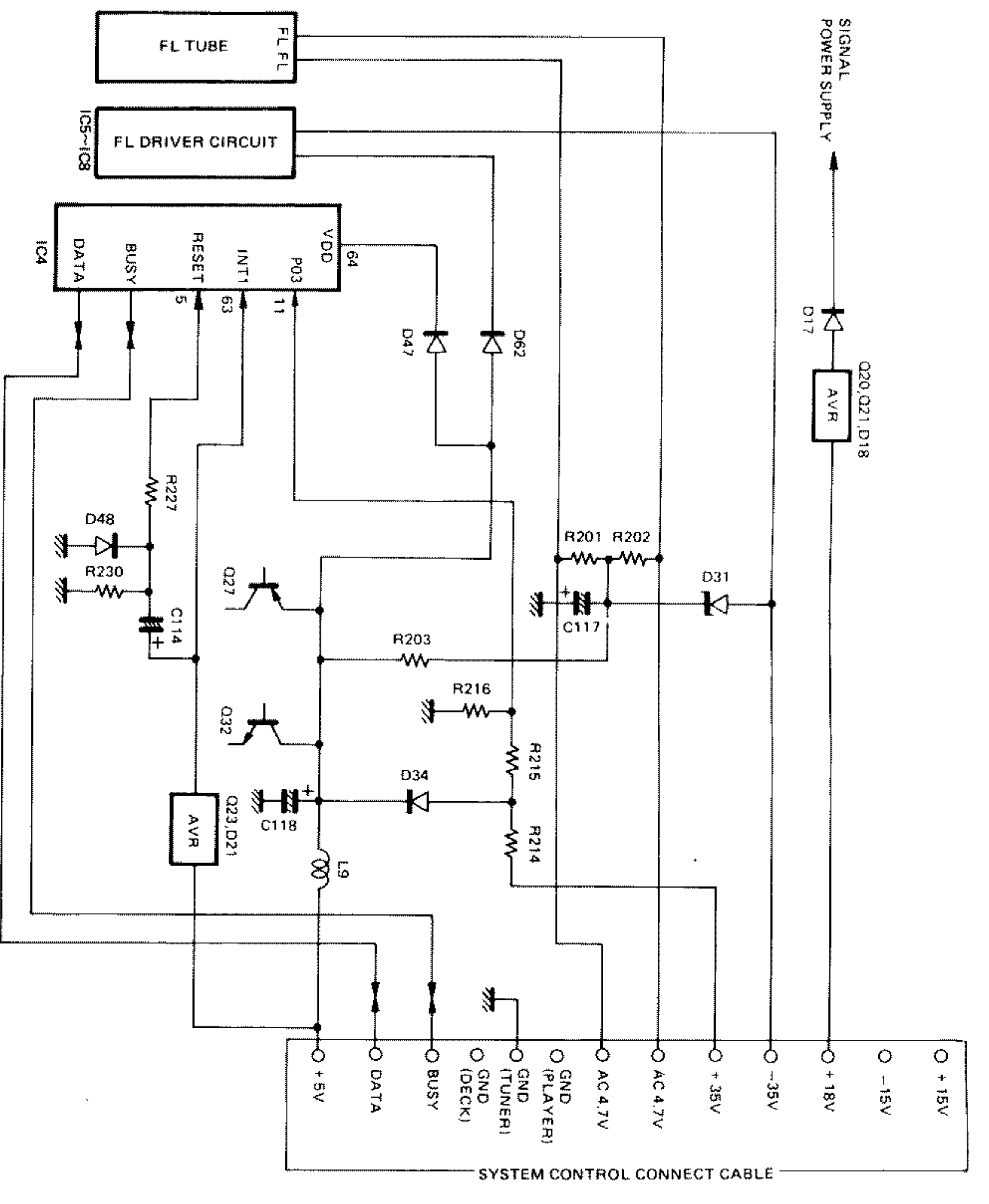

Fig. 1-6 T-3S/LS power supply

CIRCUIT DESCRIPTION

• System operation I

If the power cable is connected to an AC outlet, the power supply unit of amplifier is turned on, and the voltages of DC 5.6V, DC±35V, and AC 4.7V are supplied to the components. At this time, the microprocessor of each component is reset, then it starts the operation. FL of the tuner blinks to indicate the time, but the indicators of other components are not illuminated. The transfer of data among μ -COM's of the components for this operation is shown in Fig. 3-2.

• System operation II

If the power switch of the tuner is turned on, the tuner indicates the frequency instead of the time, and outputs the system ON signal "25H" to each component. On reception of this signal, the amplifier turns on the relay for controlling the high-voltage system, and illuminates the indicators of the selector, REC OUT, and VR position, then the LED of MUTING blinks. At this time, the key operation is permitted. LED of DIRECTION is turned on when DC±15V is applied. LED of 33rpm on the record player is turned on when DC±16V is applied, then its microprocessor starts to accept the key operation. The transfer of data among μ -COM's of the components for this operation is shown in Fig. 3-3.

CIRCUIT DESCRIPTION

Transfer of data among μ -COM through BUSY/DATA line when system is turned on by tuner (Processing by each μ -COM)

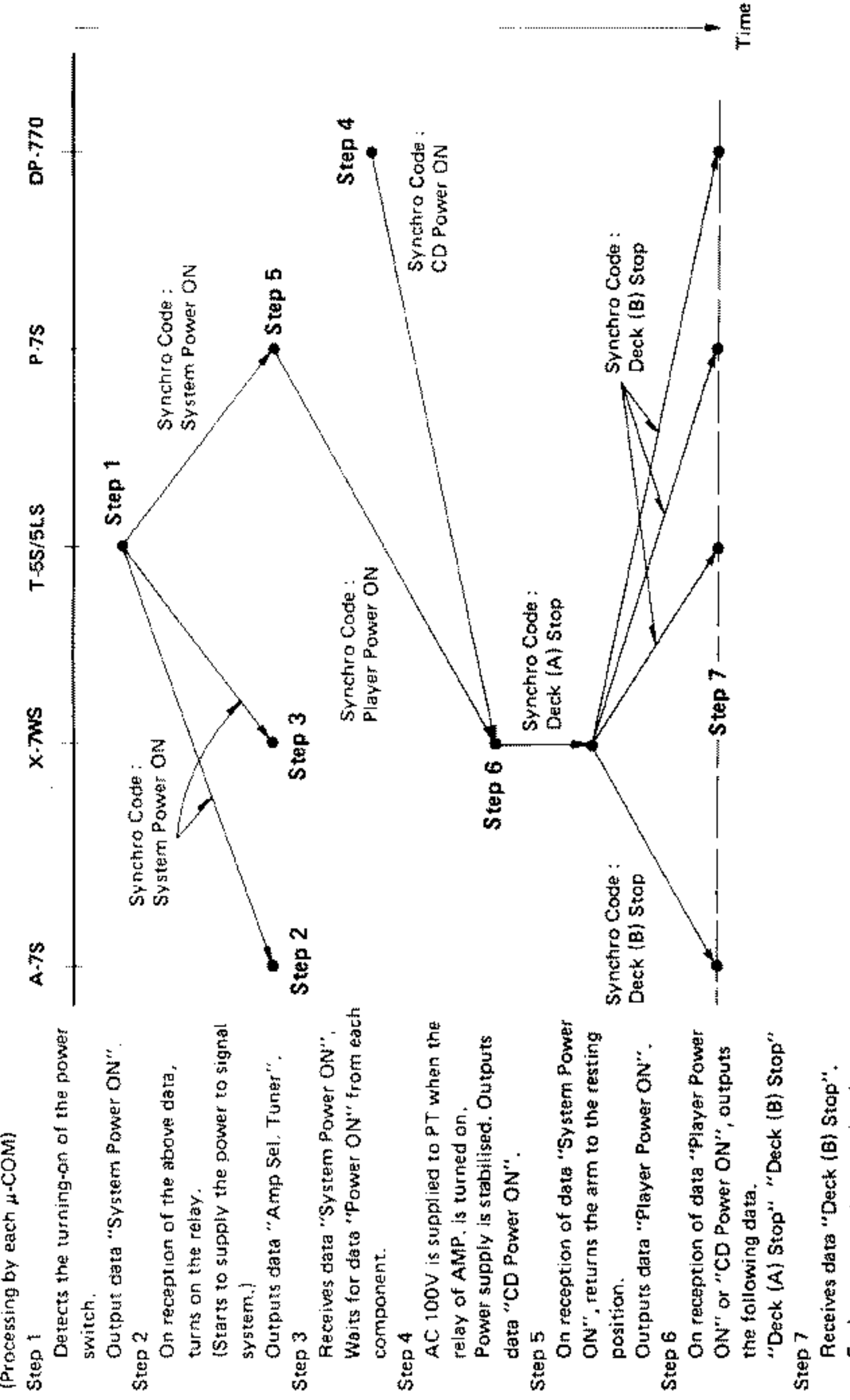

Fig. 3-3 System operation II when power ON

Transfer of data among μ -COM through BUSY/DATA line when system is turned off (Processing by each μ -COM)

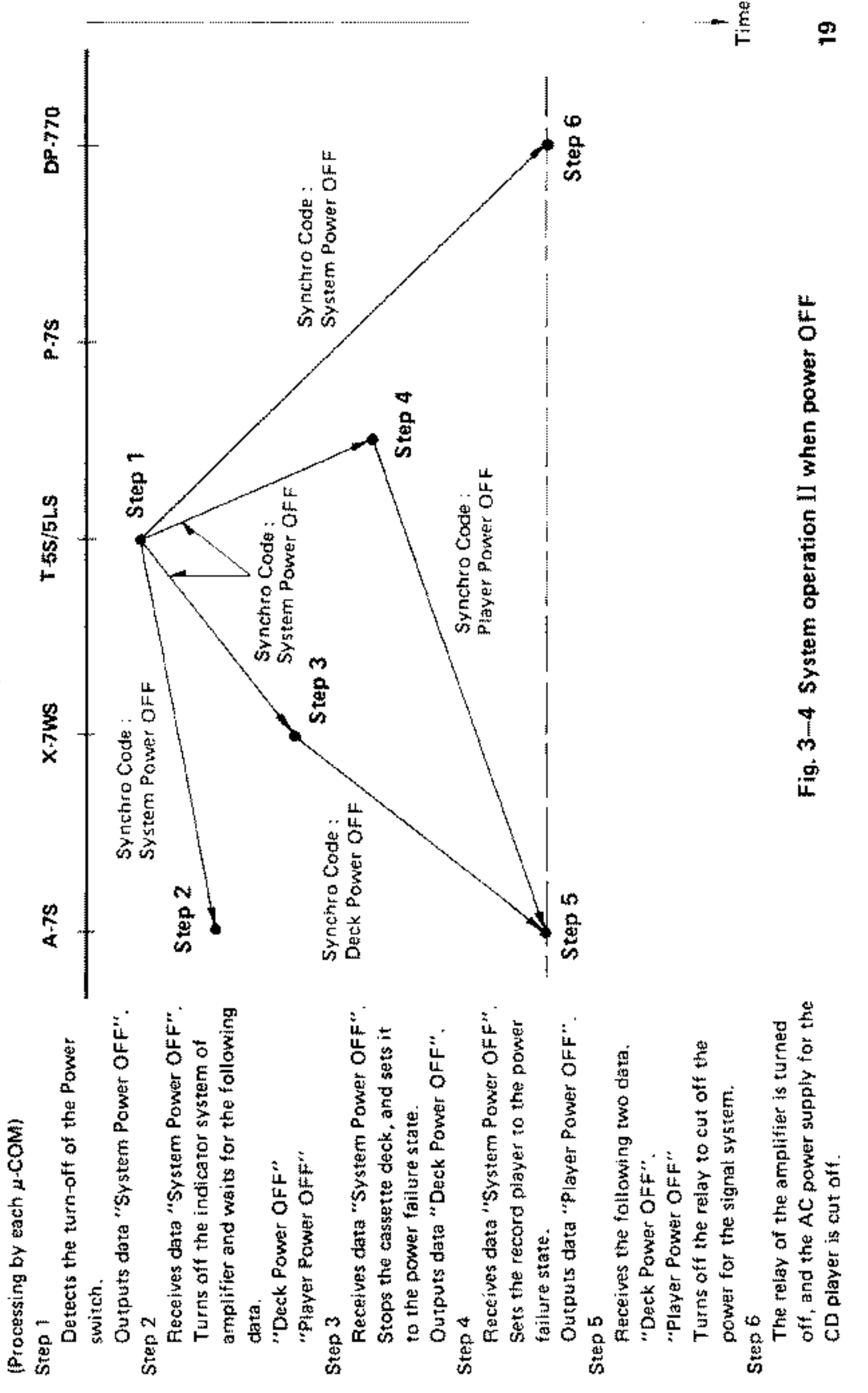

Fig. 3-4 System operation II when power OFF

• System operation I

Each μ -COM receives the reset signal, then it performs the initial resetting. μ -COM of the cassette deck outputs "Deck Power ON".

Step 2
On reception of data "Deck Power ON", outputs data "Arm Power ON".

Step 3
Receives data "Arm Power ON". Outputs the operating condition of cassette deck. Outputs the following data: "Deck (A) Stop", "Deck (B) Stop".

Step 4
On reception of reset signal, waits for about 1 second. Then, outputs data "System Power OFF".

Step 5
Receives data "System Power OFF". Outputs data "Deck Power OFF".

Step 6
Receives data "System Power OFF". Outputs data "Player Power OFF".

Transfer of data among μ -COM's through BUSY/DATA signal line for initial setting (Processing by each μ -COM)

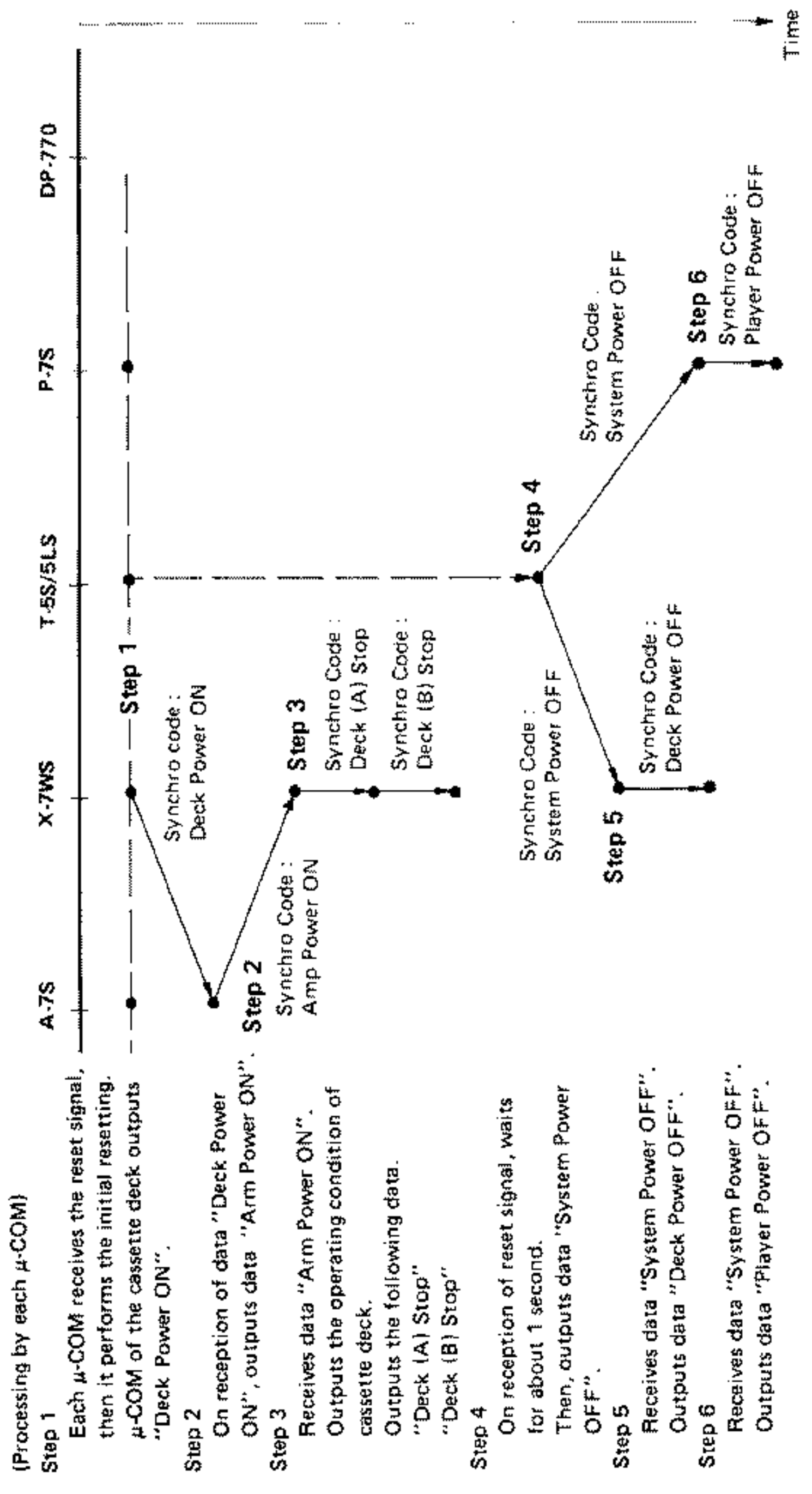

Fig. 3-2 System operation I

CIRCUIT DESCRIPTION

CIRCUIT DESCRIPTION

4. Troubleshooting the system

The components of MIDI series are designed so that they will be repaired as a system. If any abnormality is found in the operation of the system, confirm the following.

Examples of troubles : The power is not supplied when the power switch of the tuner is pressed.

The easy operation is not started.

• Check of connecting cable

Confirm that the system control connecting cable and pin cables (including the GND cable) are connected securely to each component. Check the cables and connectors for bad contact and breakage.

• Check of power supply for amplifier

The amplifier supplies the power to all the other components. Disconnect the system control connecting cable (Keep the pin cables connected), and confirm that the power supply circuit of the amplifier itself is normal.

Since the power switch is installed to only the tuner, the amplifier cannot be turned on by itself. If the system control connecting cable. However, when servicing the amplifier, it can be turned on by itself by performing the following special operation.

How to turn on the amplifier when the tuner (power switch) is not connected
Press the four keys of [TUNER], [CD], [PHONO], and [MUTING], (4-key pressing of amplifier)

• Check of each component

If the system control connecting cable and the power supply for the amplifier are normal, the power must be supplied to the system control connecting terminals of each component. In this case, one of following three items in each component is possibly the cause of the trouble, thus check them.

- 1 Power supply for microcomputer (DC 5.0V)
- 2 Microcomputer
- 3 Outside circuit and pattern

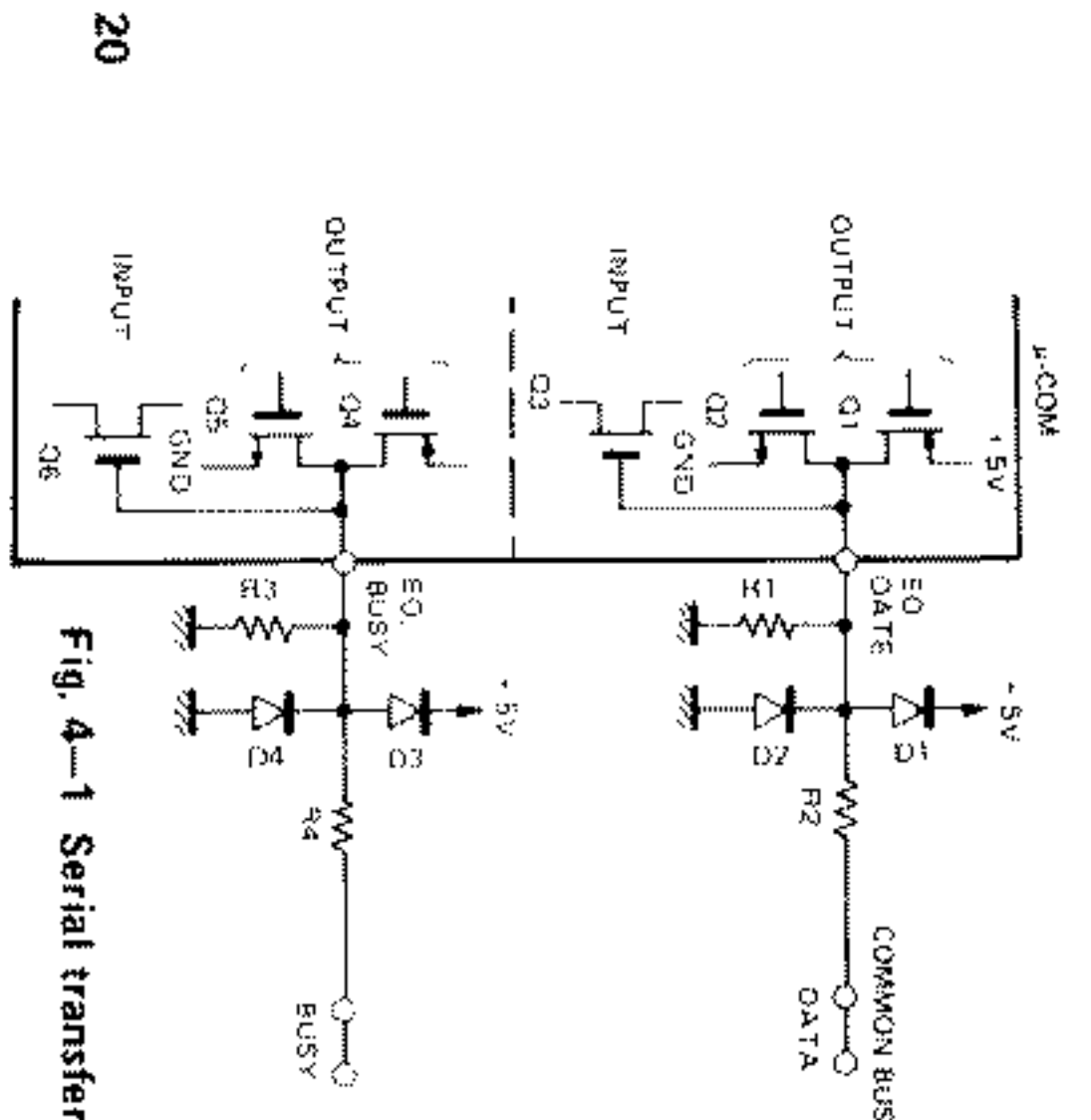

Fig. 4-1 Serial transfer port details

• How to find the trouble component

By operating the components one by one and observing their indication and operation, the troubled one may be found. The following are the examples of how to find the troubled one.

Example 1 : F1 of the tuner does not indicate any thing when the AC power cable is connected to an AC outlet.

Note : F1 of the tuner is not illuminated, if any one of -35V, AC 4.7V, and DC 5V fails.

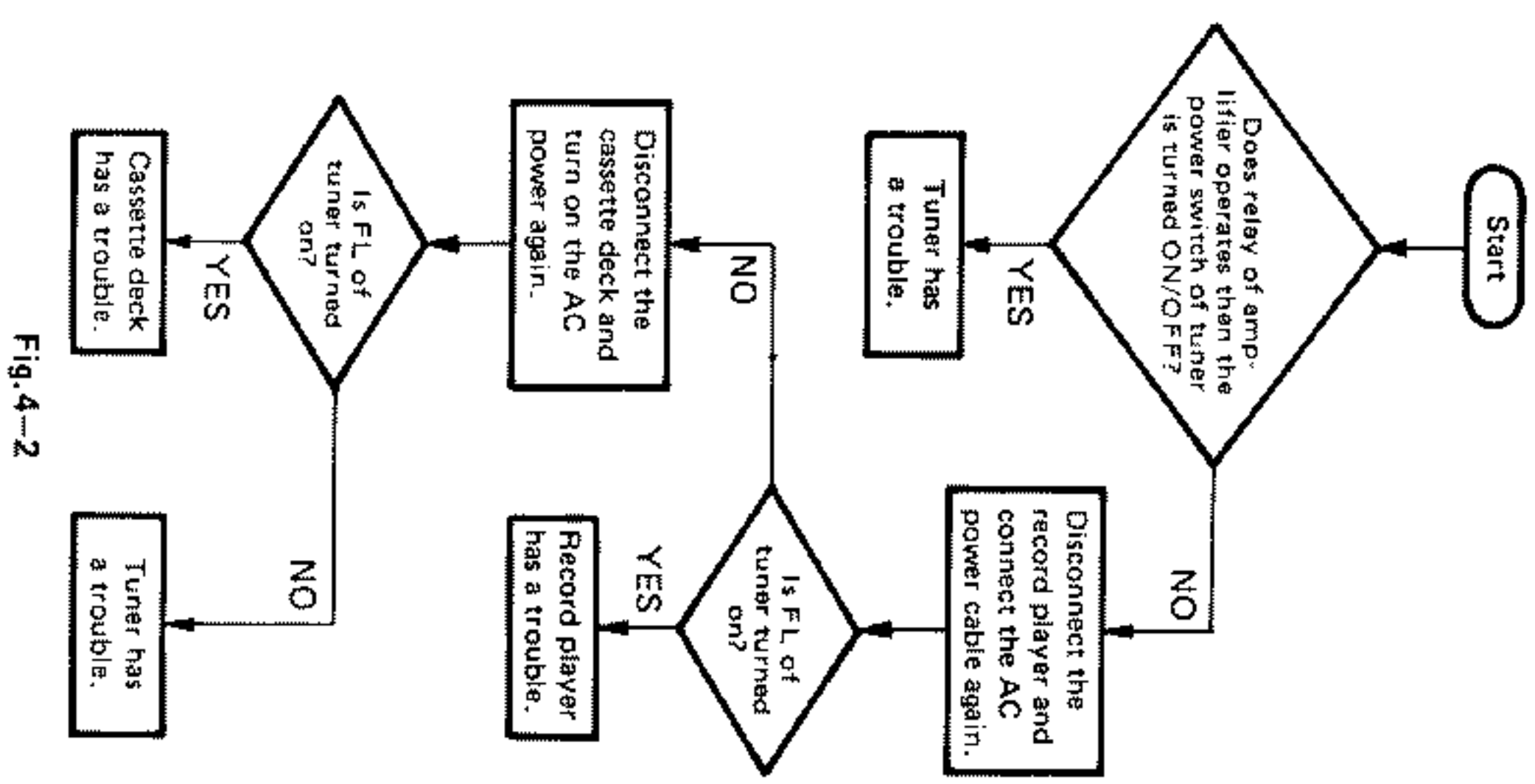

Fig. 4-2

The tuner FL goes on and off after AC power is supplied. Even if you push the POWER SW, the indicators for other components will not light up because the relay in the amplifier is not turned on.

The fact that the tuner FL goes on and off means that the circuits to other components at -35V, AC 4.7V and DC 5.0V might be open but never be shortcircuited.

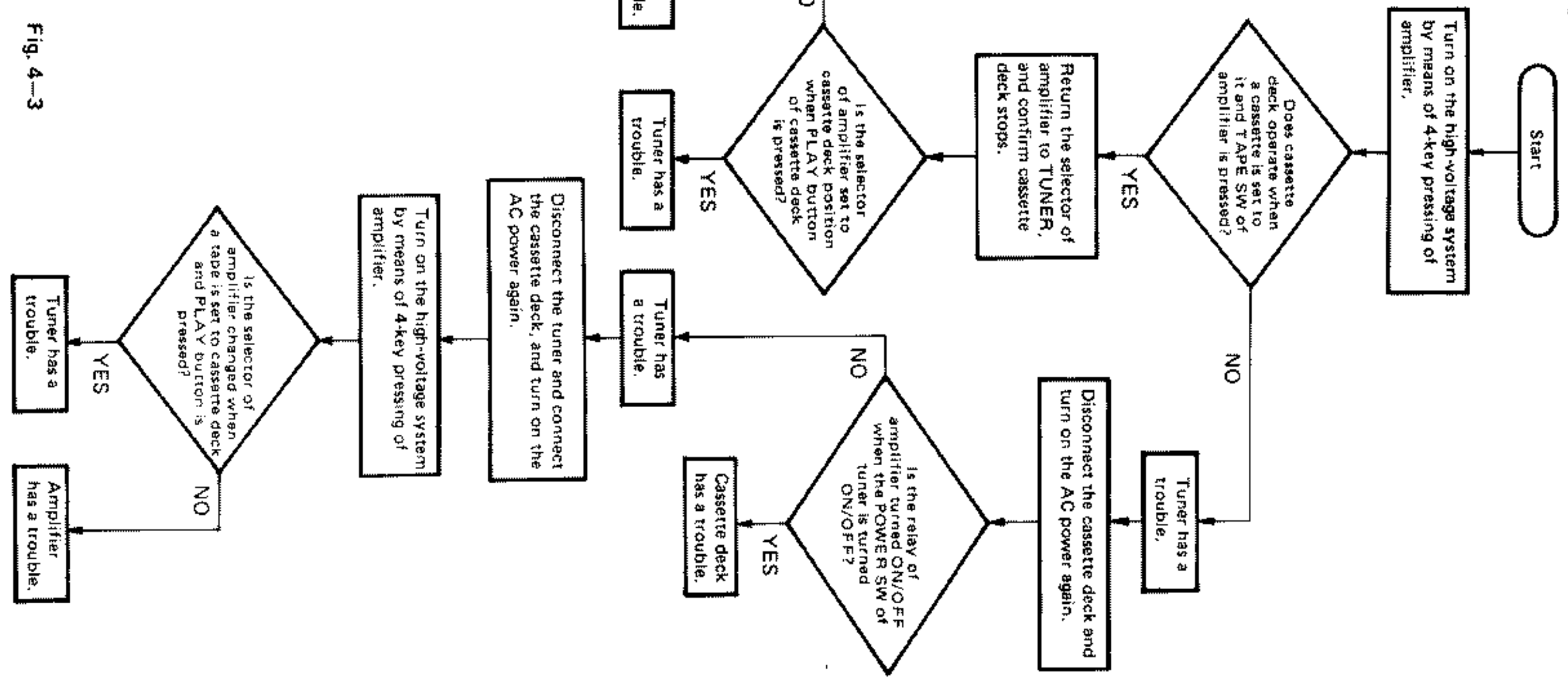

Fig. 4-3

ADJUSTMENT/REGLAGE/ABGLEICH

ADJUSTMENT/REGLAGE/ABGLEICH

ADJUSTMENT

No.	ITEM	INPUT SETTINGS	OUTPUT SETTINGS	AMPLIFIER SETTINGS	ALIGNMENT POINTS	ALIGN FOR	FIG.
Set the controls and switches as follows: POWER: ON							
1	IDLE CURRENT	--	Connect a DC voltmeter across CP1 (L) CP2 (R)	VOLUME: 0	R39.41 (L) R40.42 (R)	5mV ~ 40mV	(a)

* If meter reads is high, cut resistor R41(R42)
if meter reads is low, cut resistor R39(R40)

REGLAGE

N°	ITEM	REGLAGE DE L'ENTREE	REGLAGE DE LA SORTIE	REGLAGE DE L'AMPLIFICATEUR	POINTS D'ALIGNEMENT	ALIGNER POUR	FIG.
1	COURANT DE POLARISATION	--	Connecter un voltmètre de CC sur CP1 (G) CP2 (D)	VOLUME: 0	R39.41 (G) R40.42 (D)	5mV ~ 40mV	(a)

ABGLEICH

NR.	GEGENSTAND	EINGANGS-EINSTELLUNG	AUSGANGS-EINSTELLUNG	VORSTÄRKER EINSTELLUNG	ABGLEICH-PUNKTE	ABGLEICHEN FÜR	ABB.
Die Register und Knöpfe wird folgt einstellen: POWER: ON							
1	LEERLAUFSTROM	--	Einen Gleichspannungsmesser über CP1 (L) CP2 (R) anschließen.	VOLUME: 0	R39.41 (L) R40.42 (R)	5mV ~ 40mV	(a)

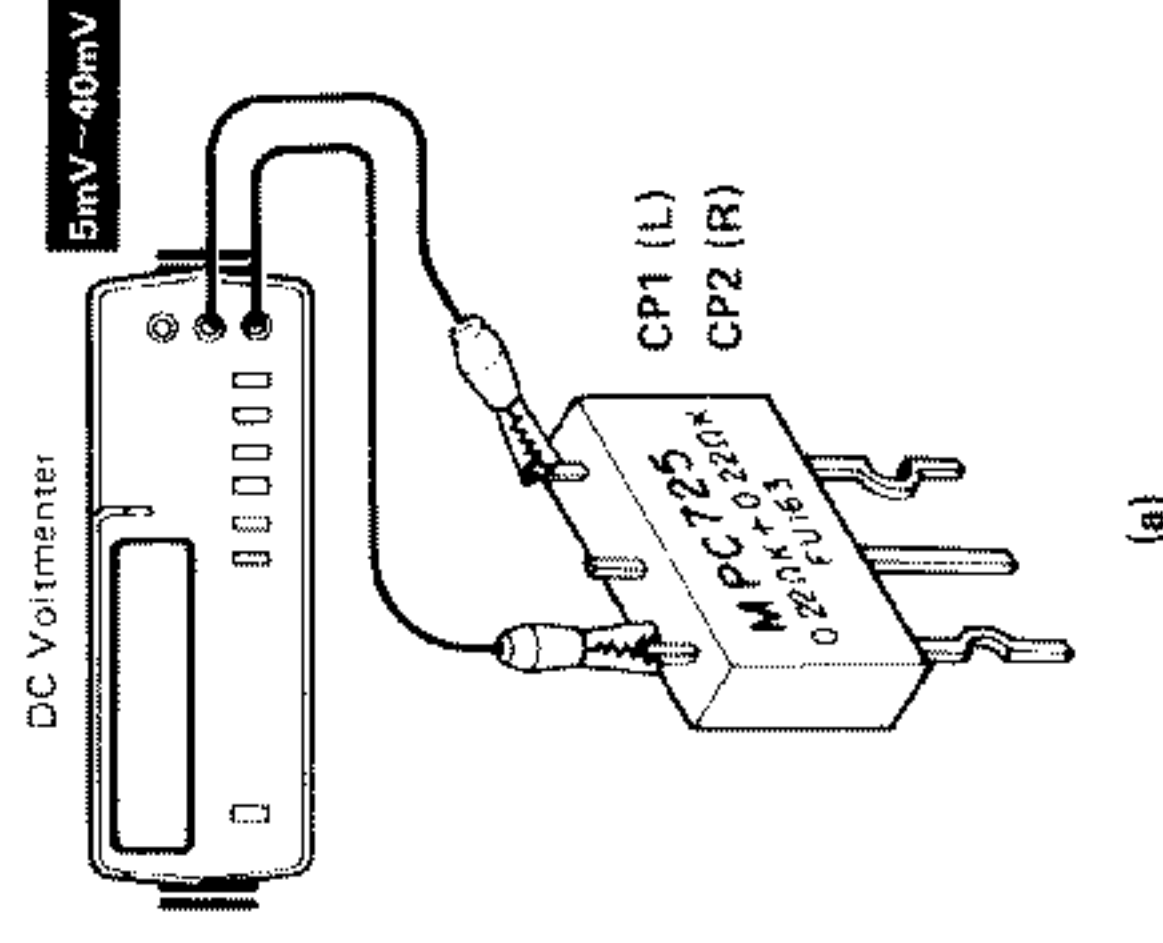

A-7S A-7S

PC BOARD

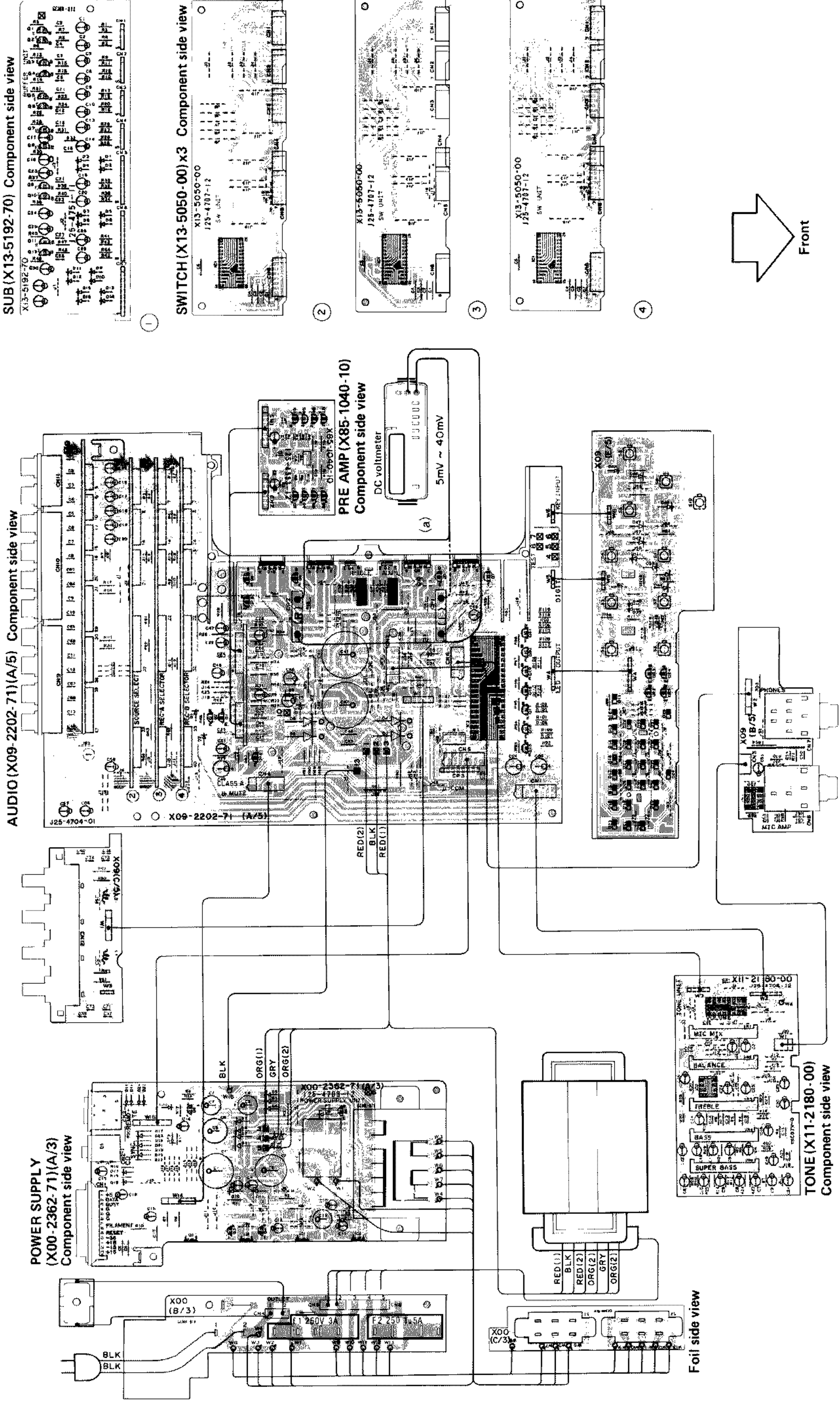

Refer to the schematic diagram for the values of resistors and capacitors

PC BOARD

X00-2362-71

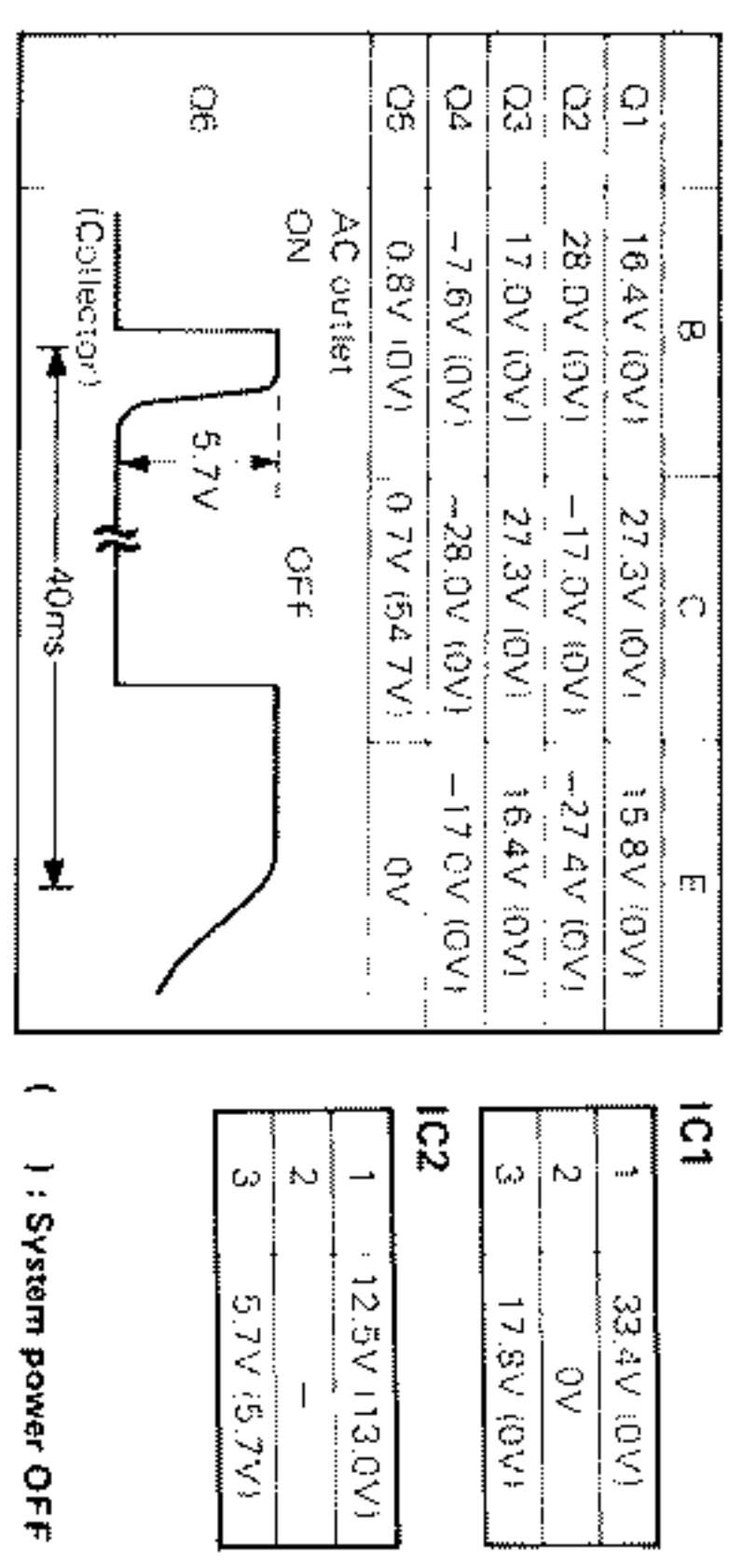

X11-2180-00

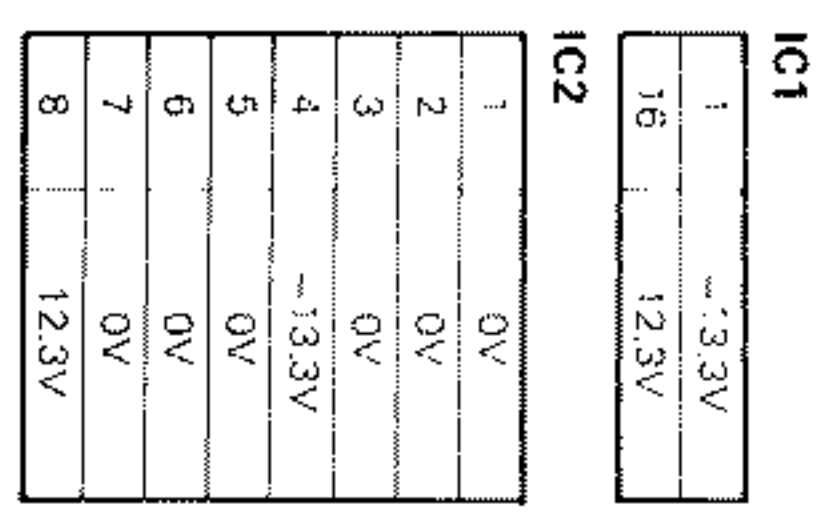

X13-5050-13

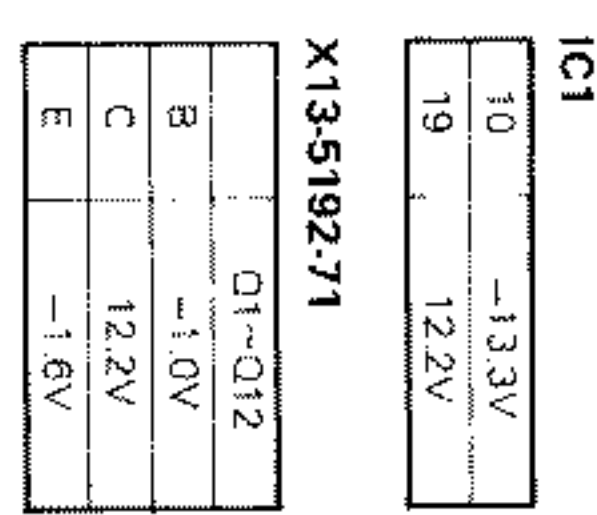

X09-2202-71

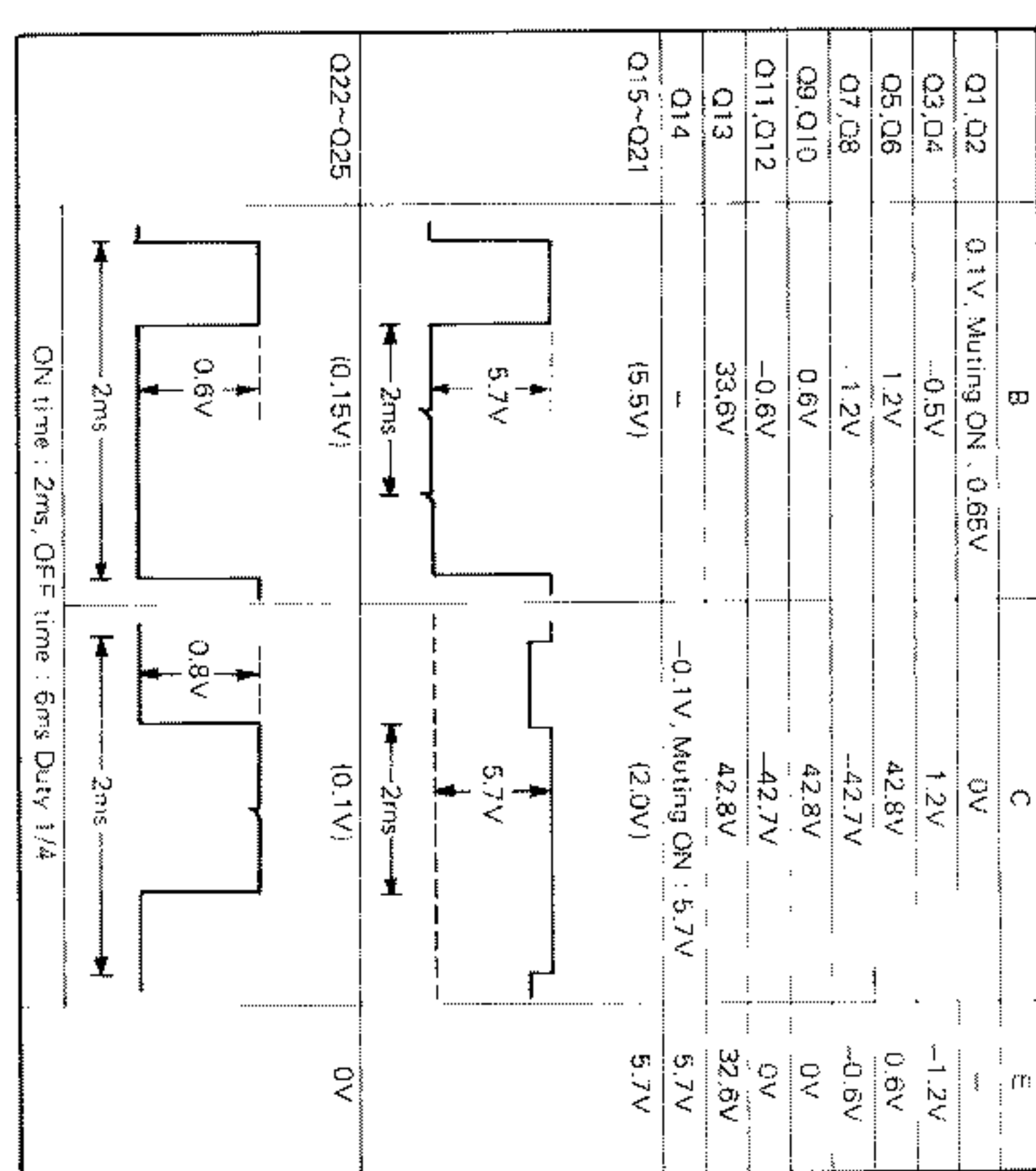

() : Ref. Value

IC1	1	2	3	4	5	6	7	8
	0V	0V	0V	-13.4V	0V	0V	0V	12.2V

POWER SUPPLY (X00-2362-71)(A/3)
Component side view

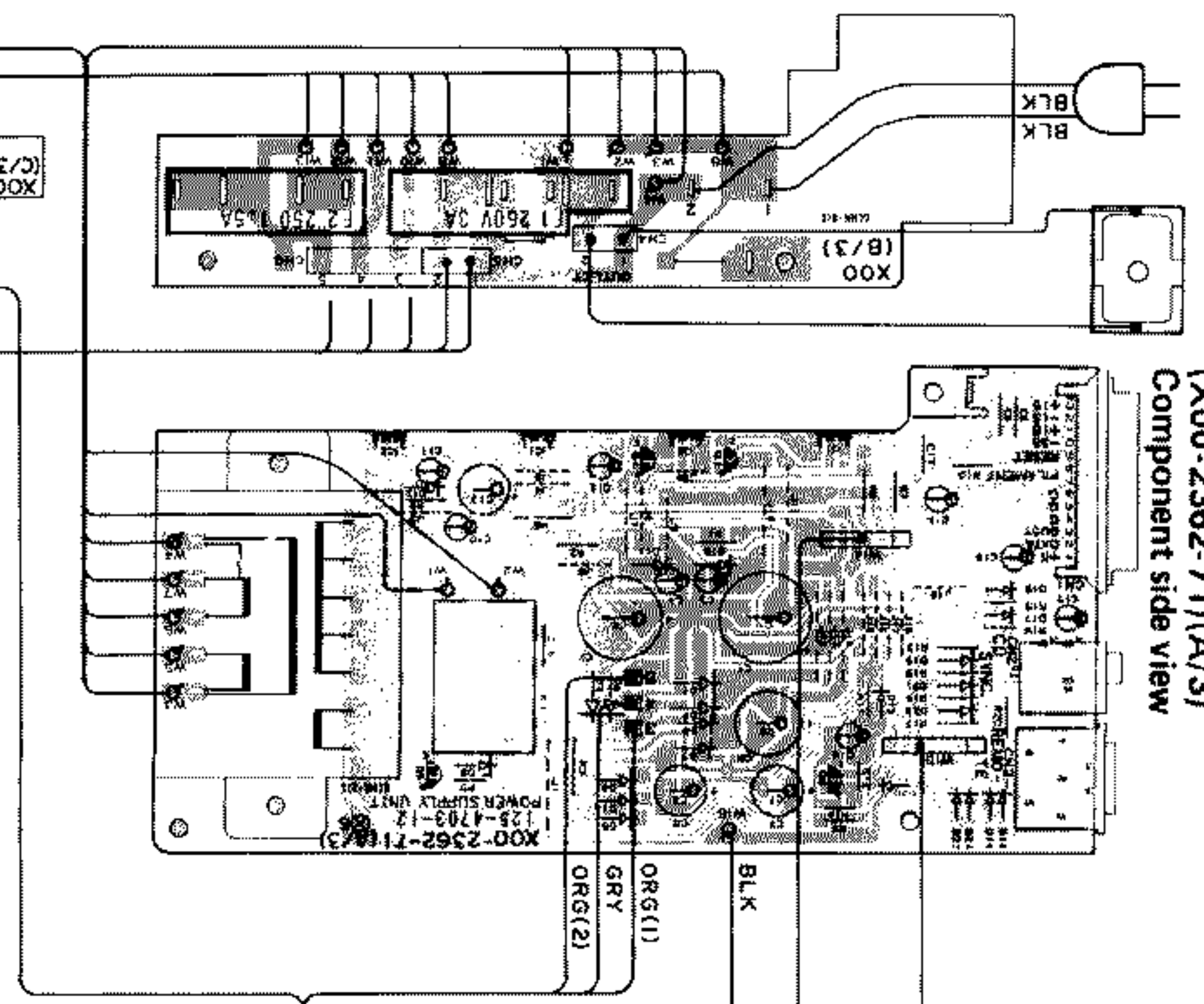

Foil side view

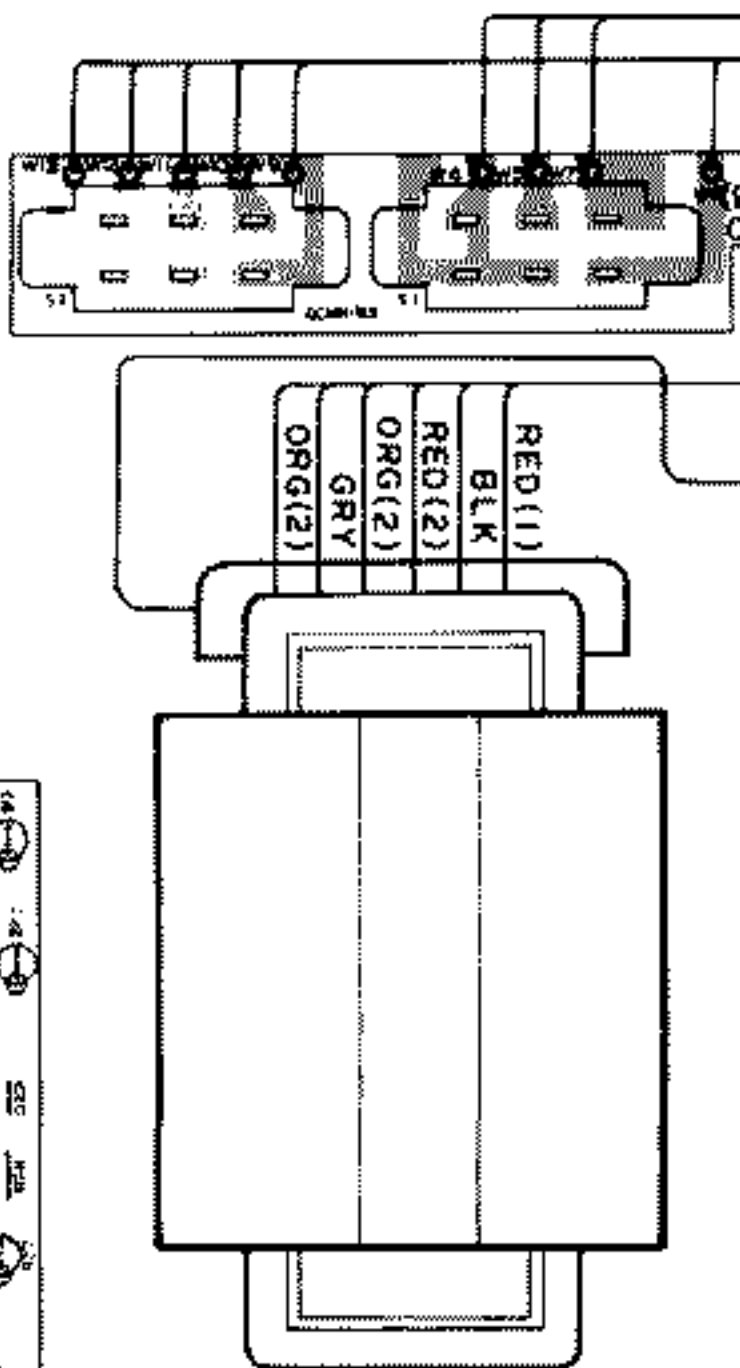

AUDIO(X0

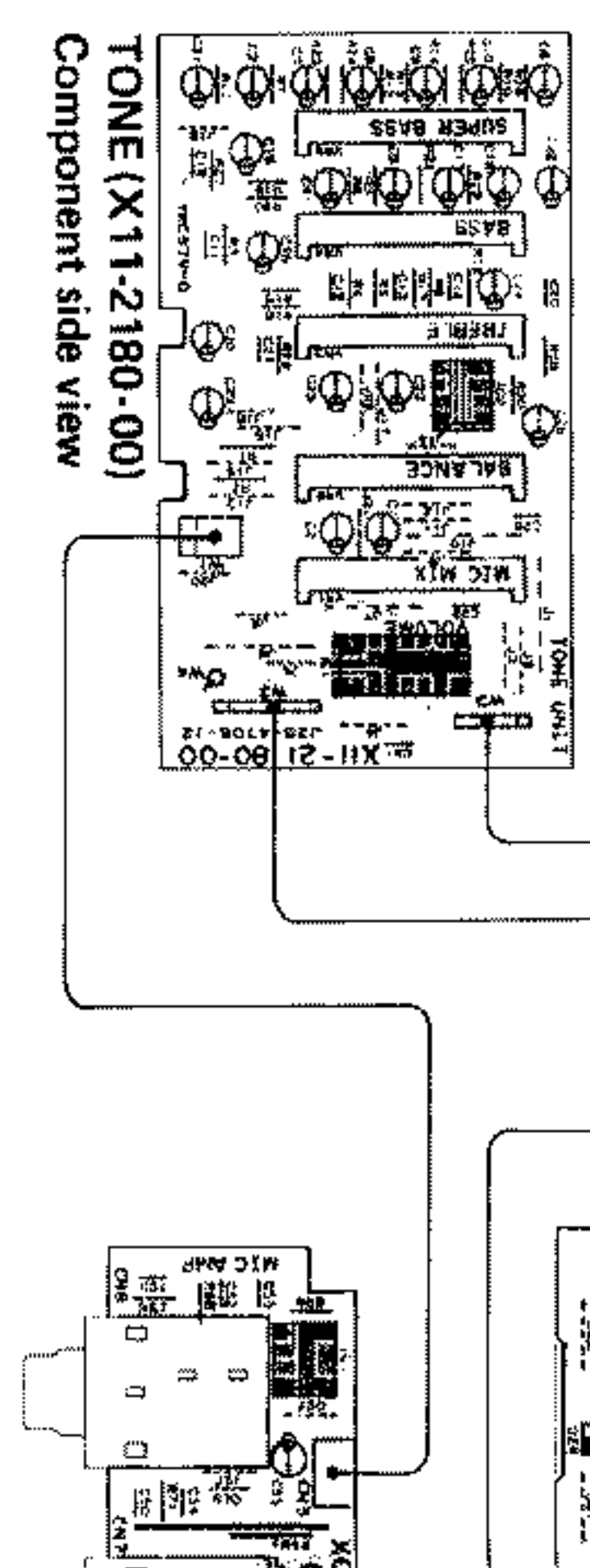

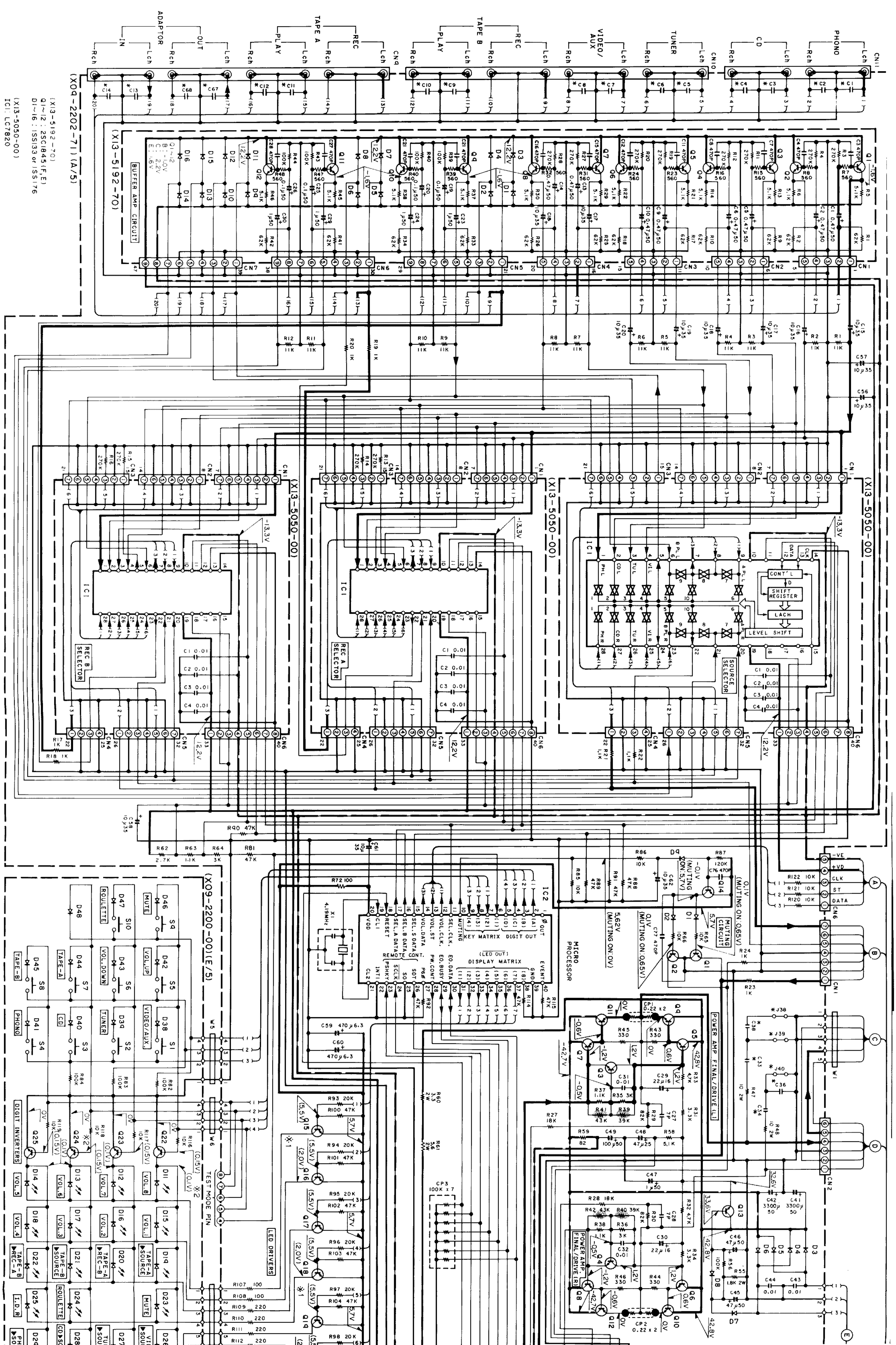

(X09-2202-71) (A/5)

(X13-5192-70)

(X13-5050-00)
 Q1~12: 2SC1845 (F.E.)
 D1~16: 1SS133 or 1SS176
 IC1: LC7820

(X13-5050-00)

(X13-5050-00)

(X13-5050-00)

(X09-2200-00) (E/5)

(X13-5050-00)

- 2SA1127NC
- 2SA1284
- 2SA1284
- 2SA733(A)
- 2SA992
- 2SC1685
- 2SC1845
- 2SC2003
- 2SC3244
- 2SC945(A)
- 2SD1302

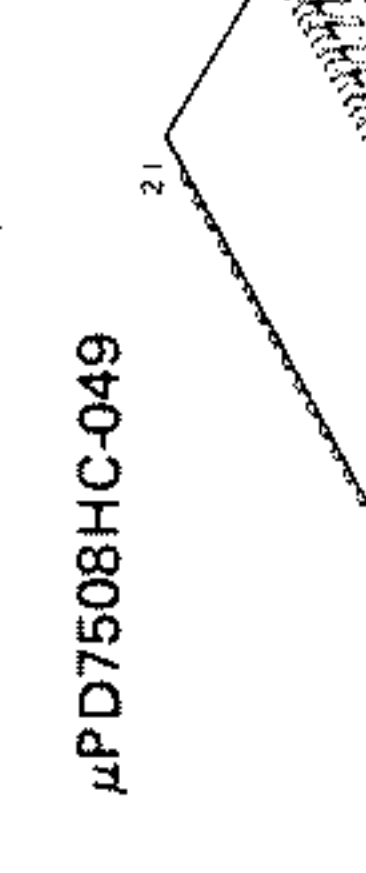
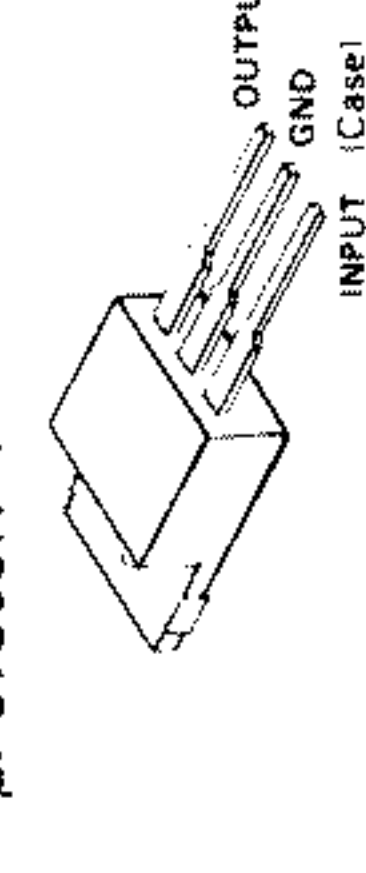
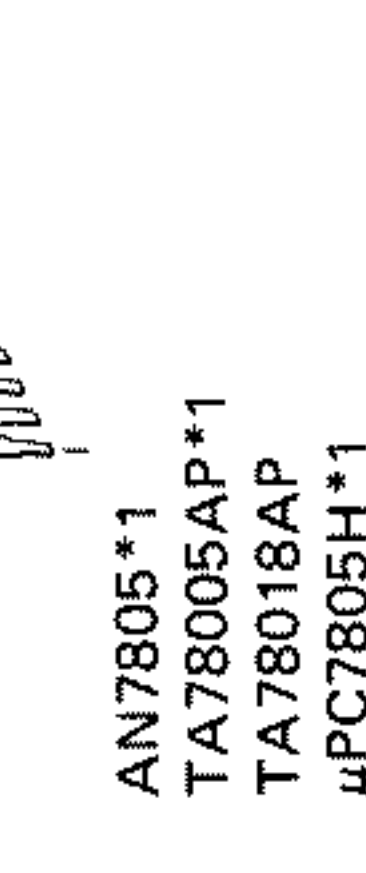
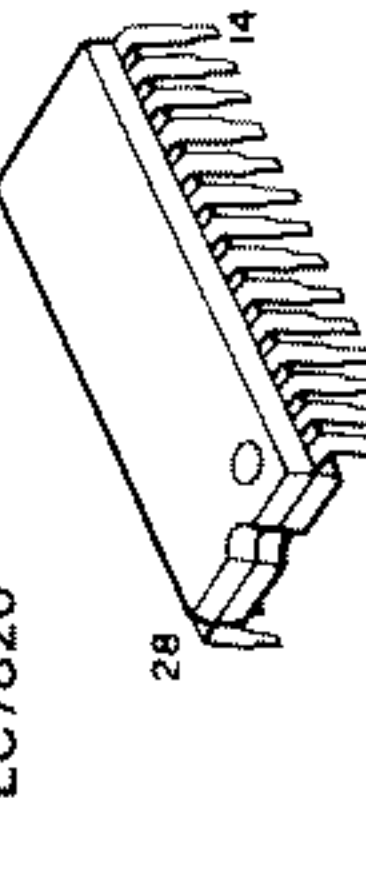
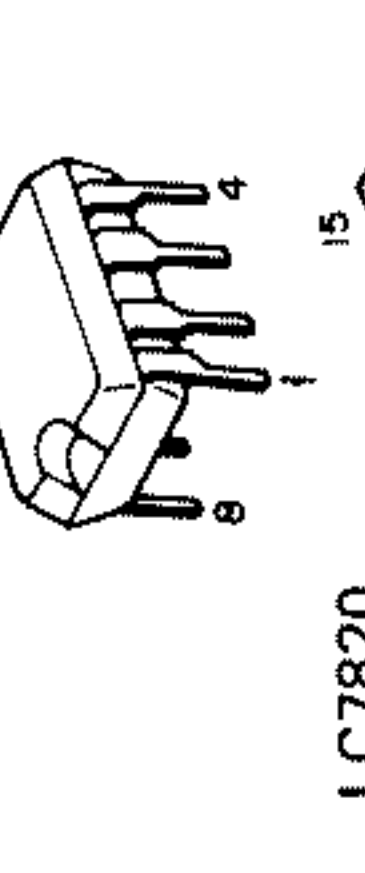
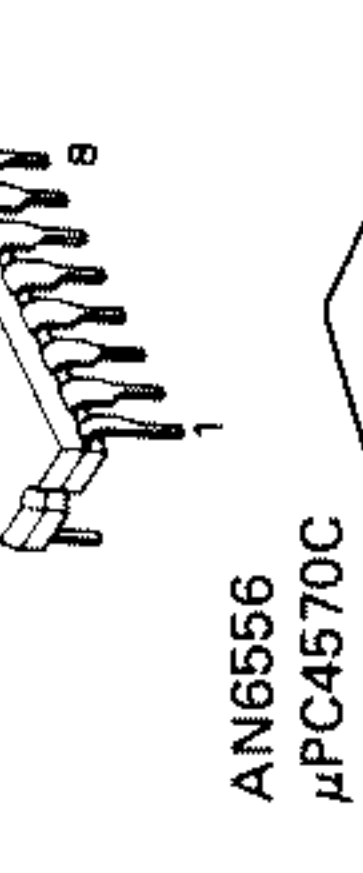
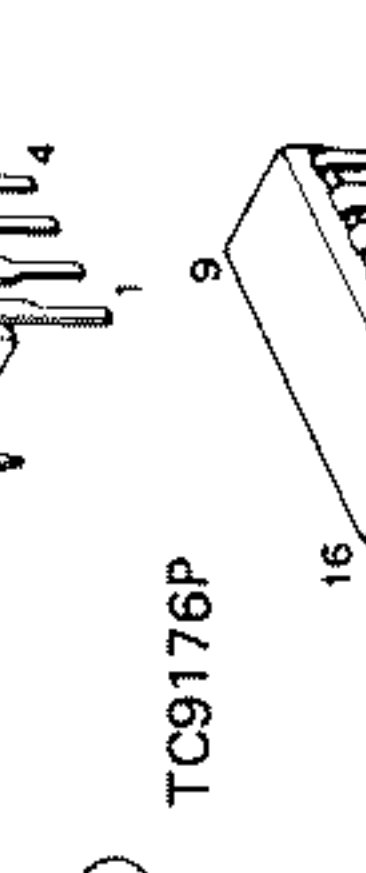
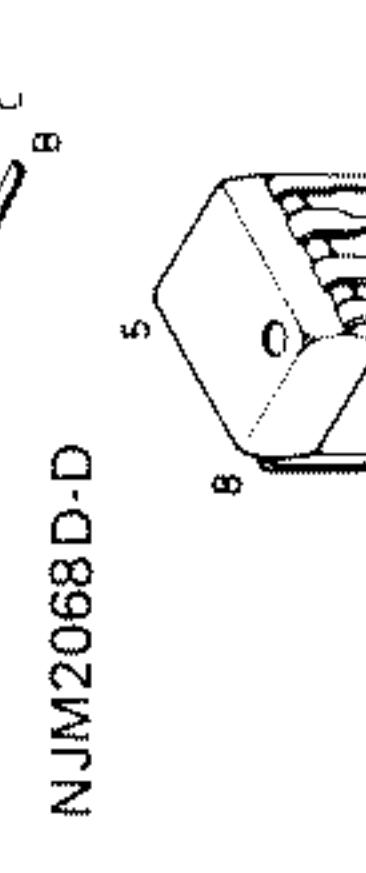
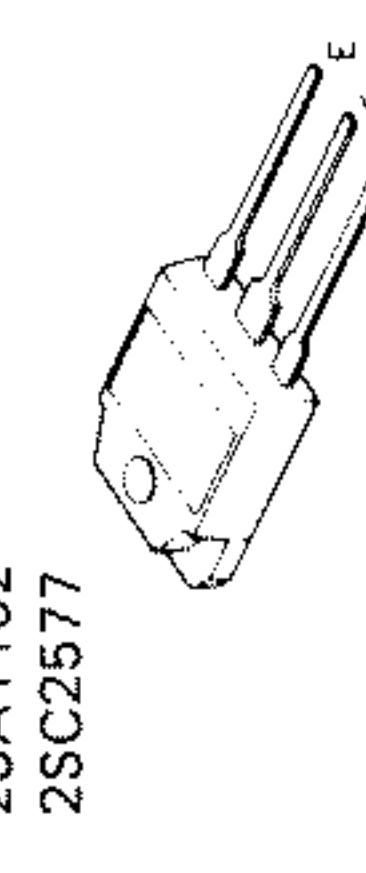
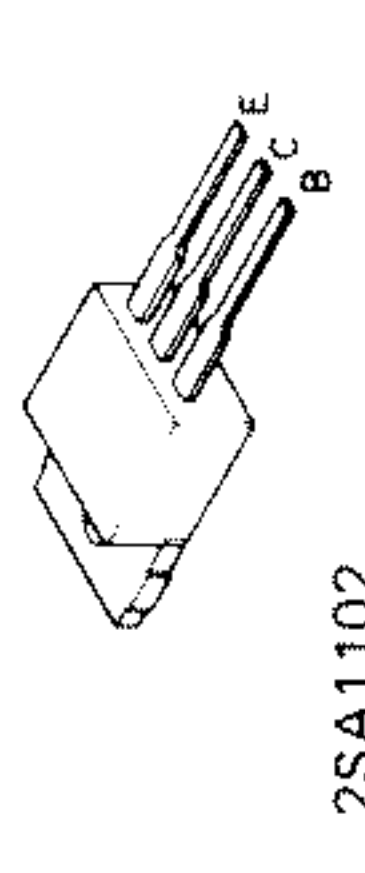
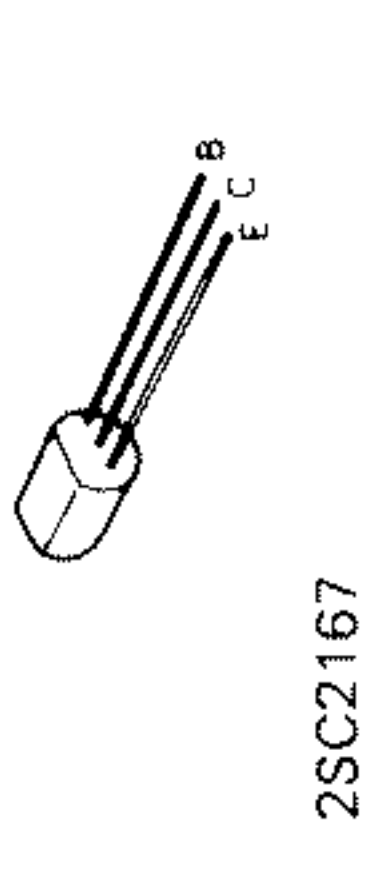

A-7S
KENWOOD

• DC voltages are as measured with a high impedance voltmeter with no signal input. Values may vary slightly due to variations between individual instruments or/and units.

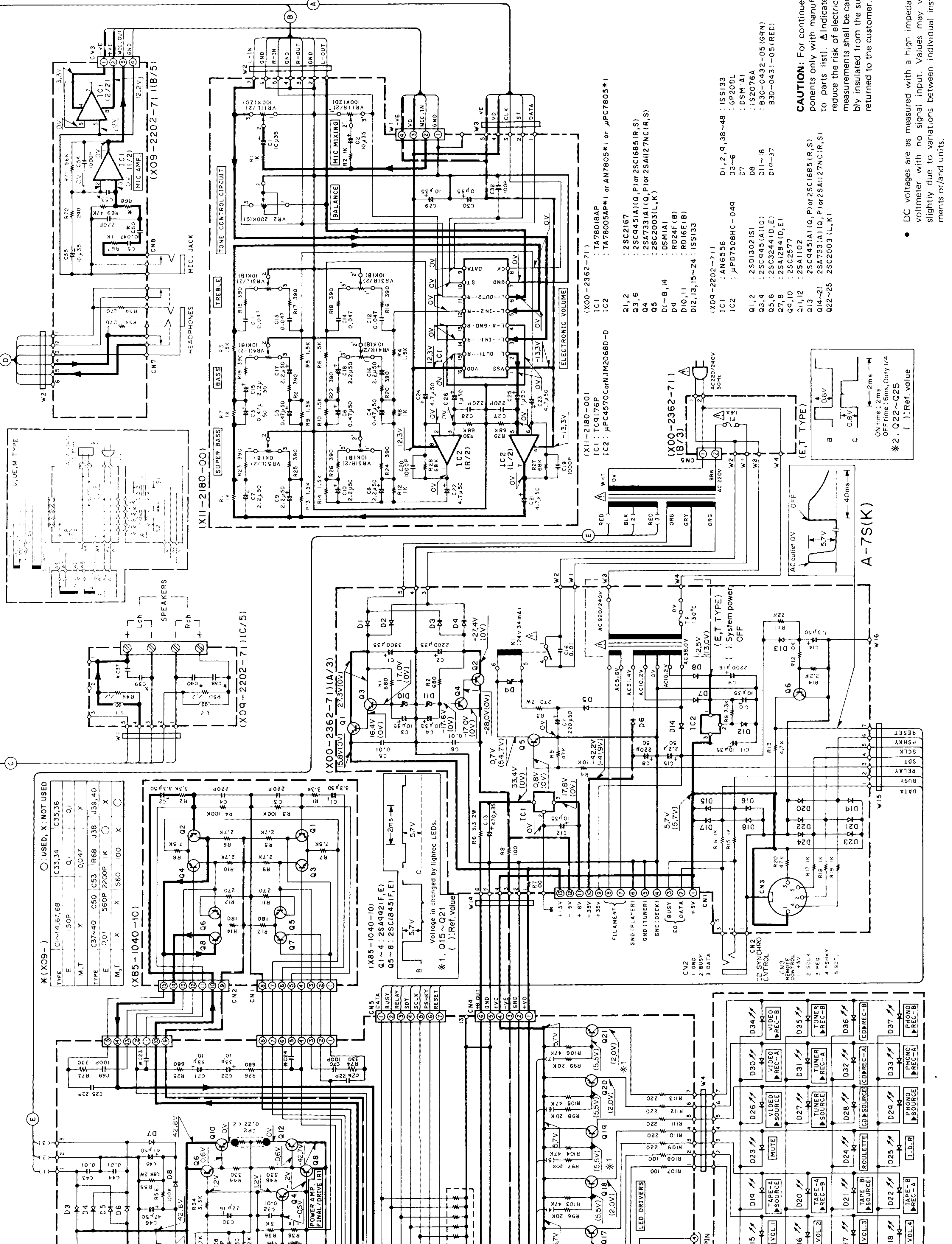

*(X09-)

TYPE	C1~4, 6, 7, 68	C33, 34	C35, 36
E	150P	X	Q1
M, T	X	0, 047	X
TYPE	C37~40	C50	C53
E	0, 01	560P	2200P
M, T	X	X	560
			100
			X

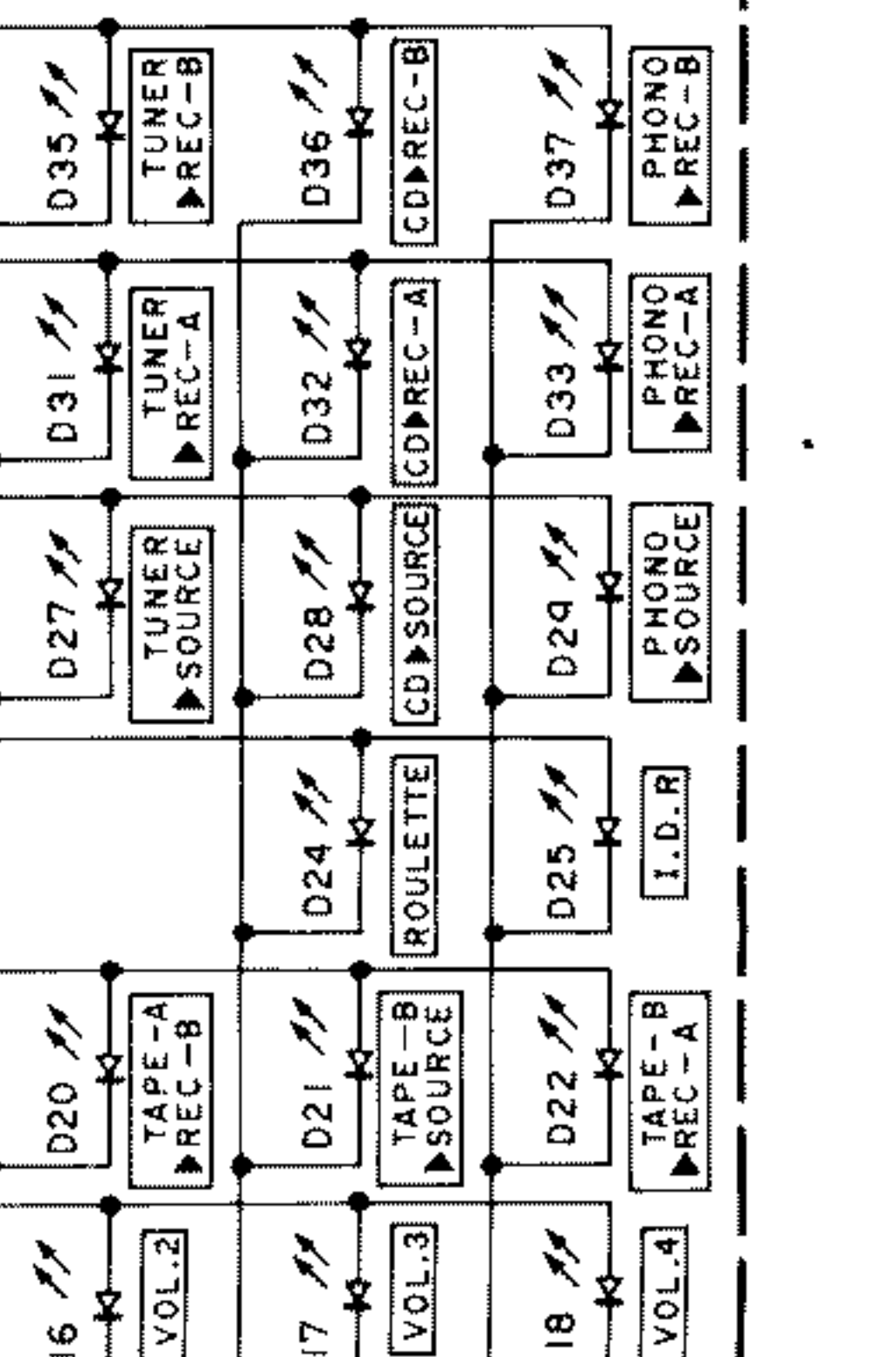
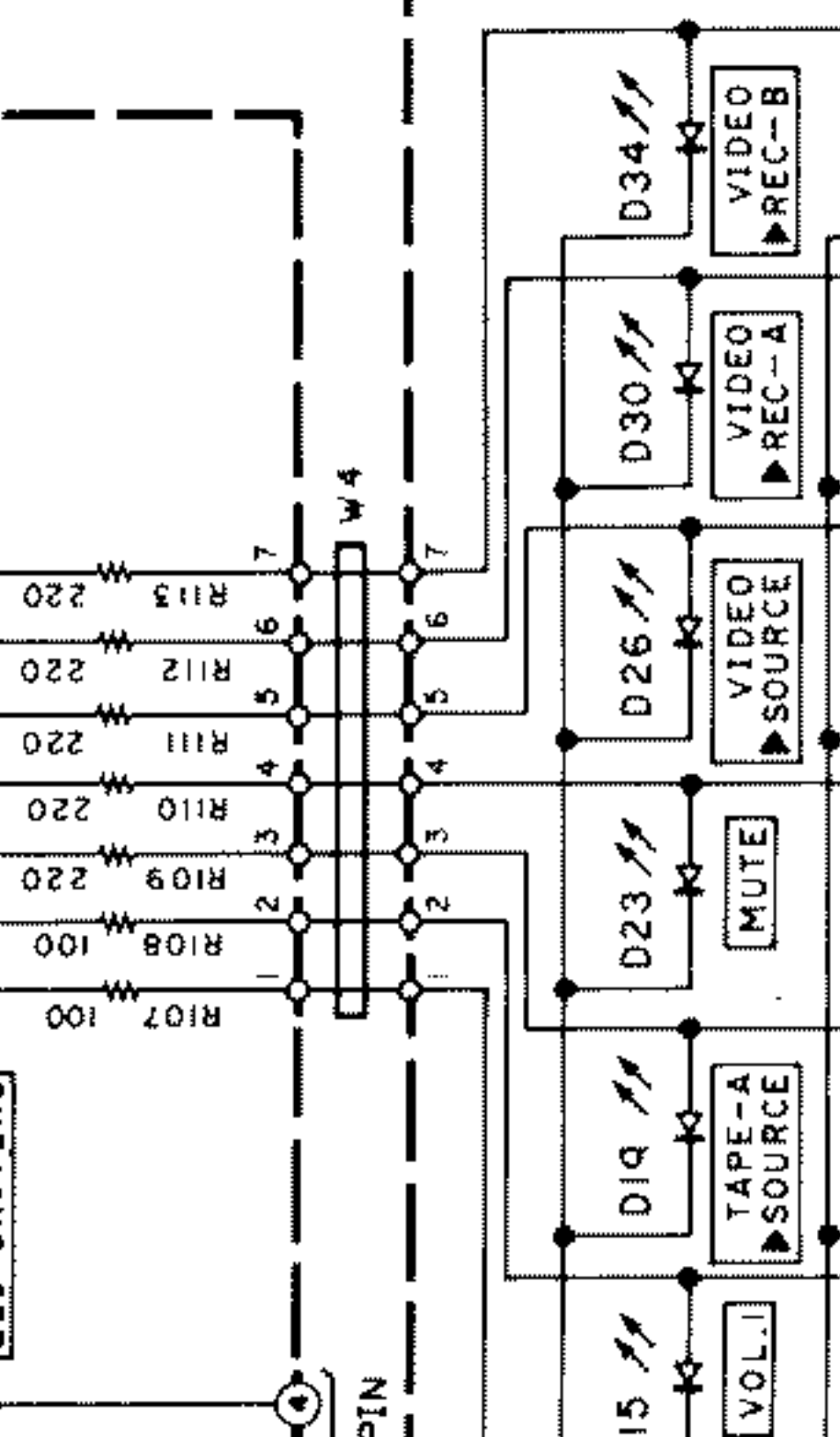
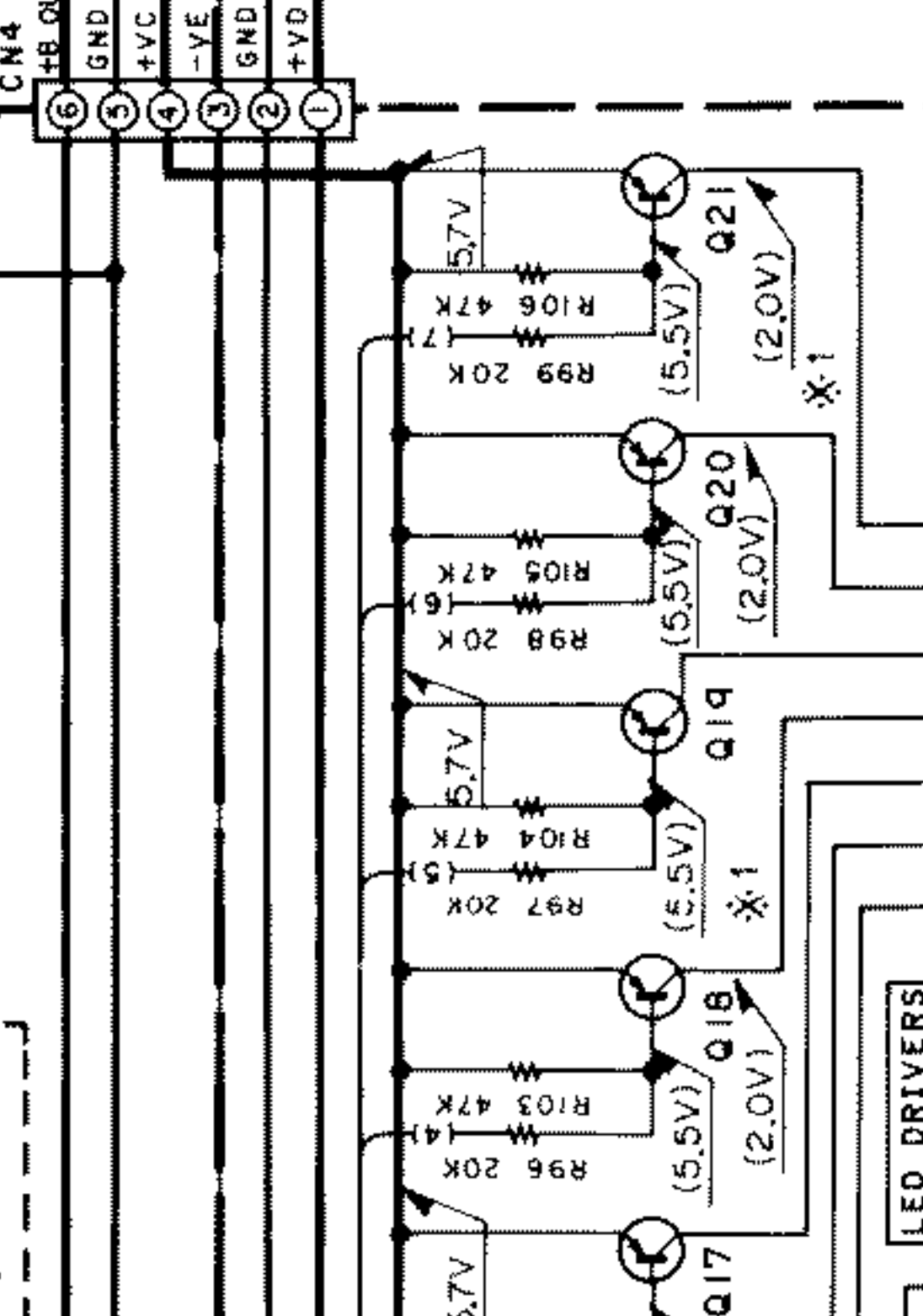
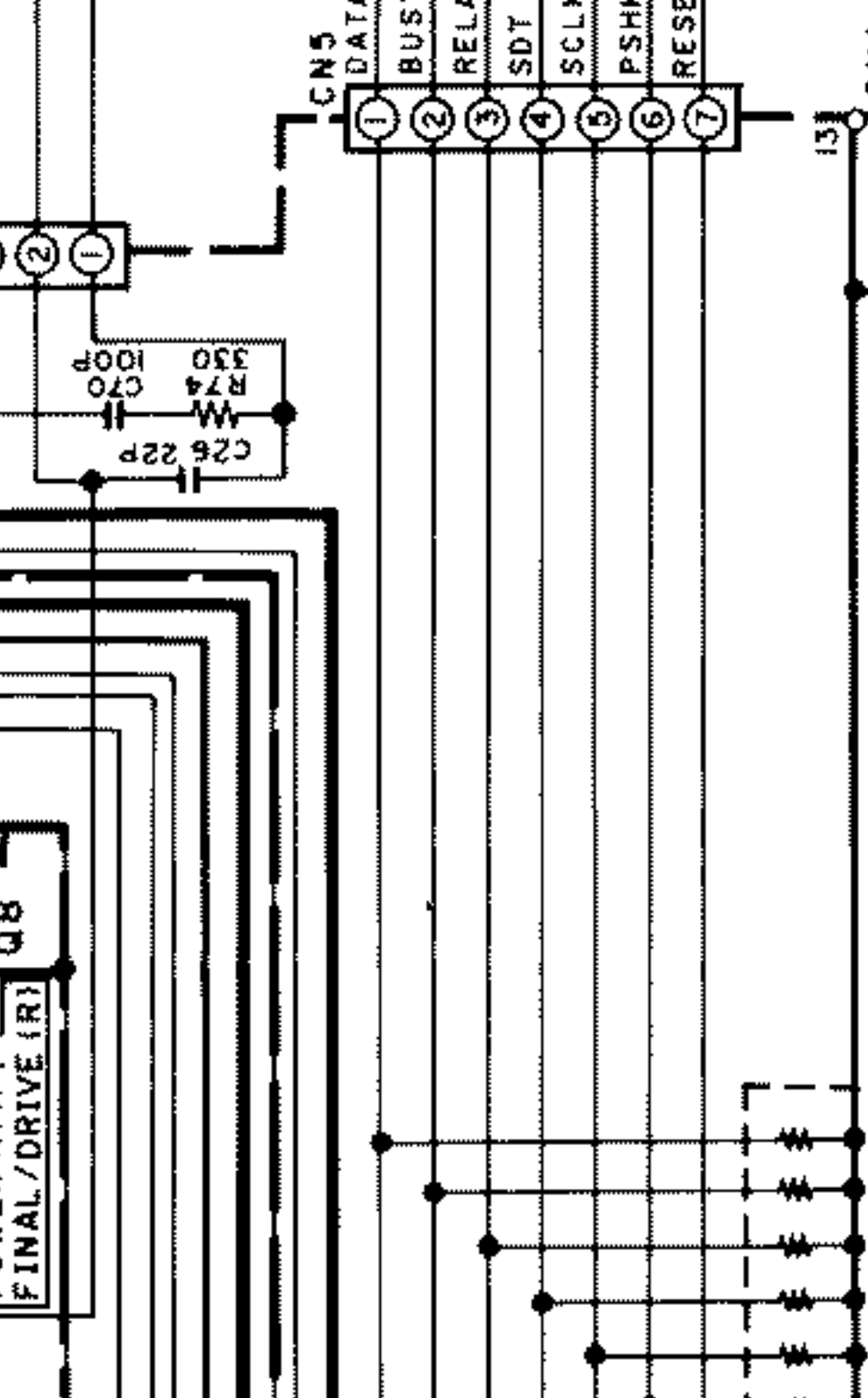
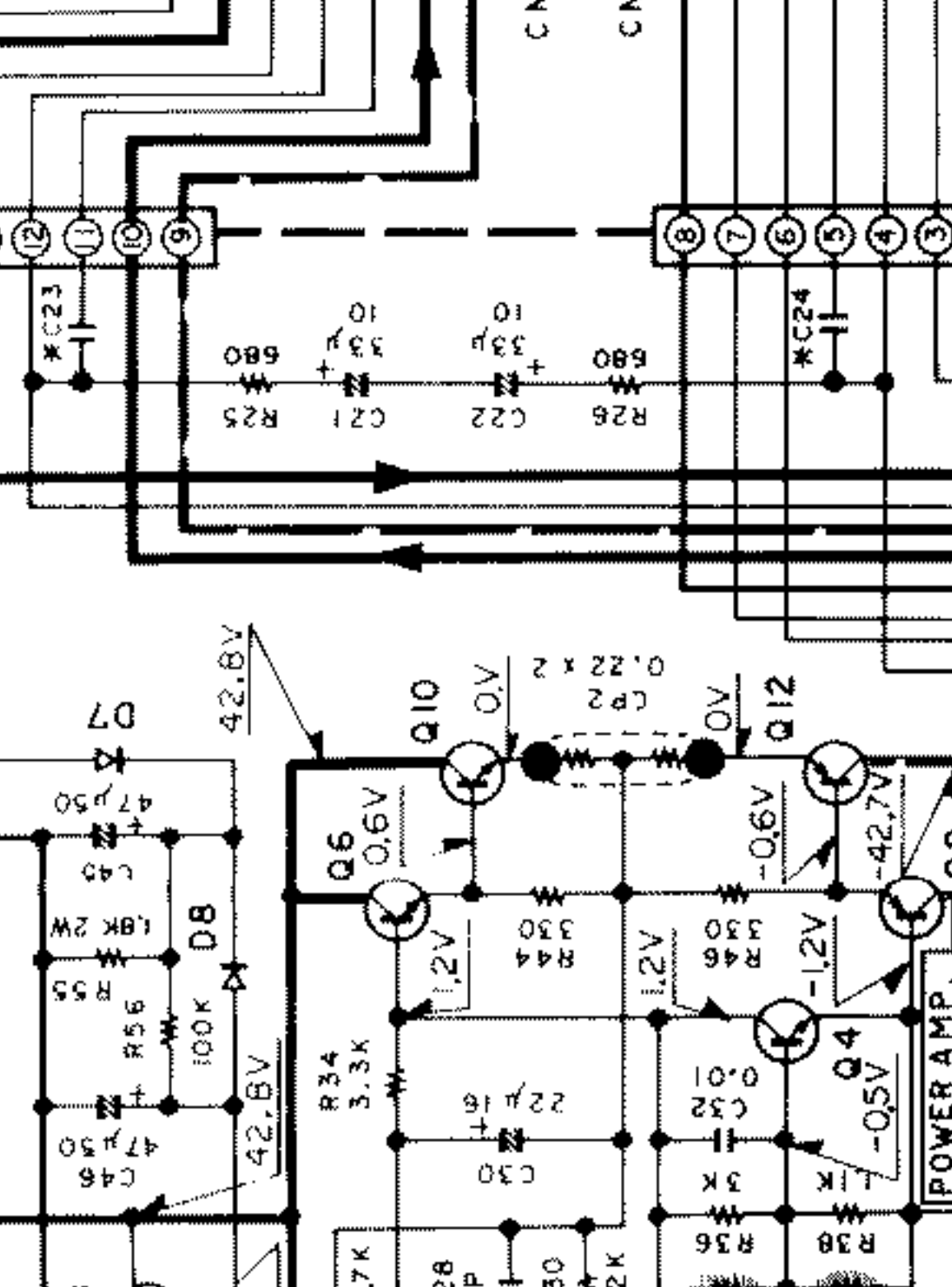
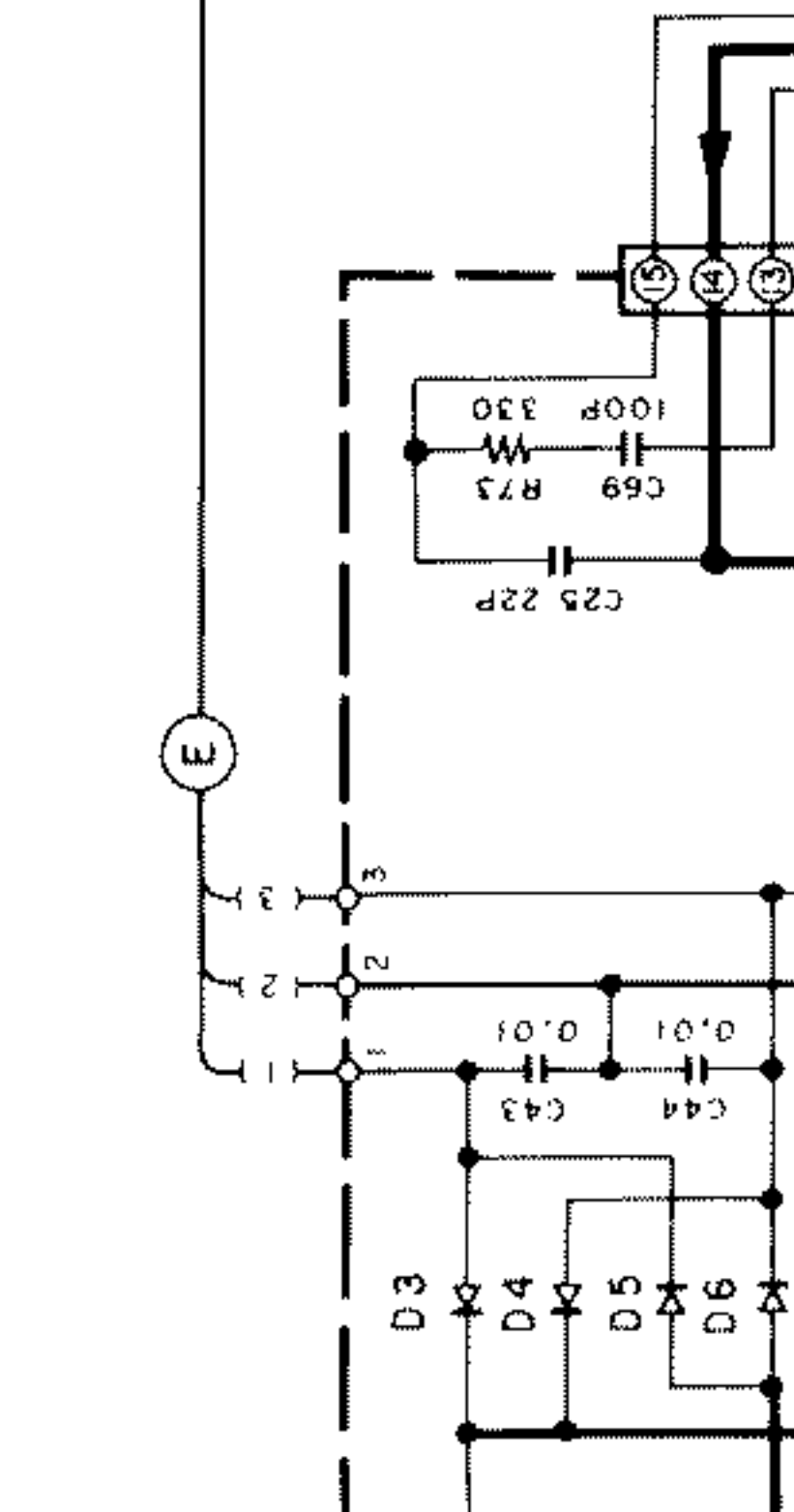
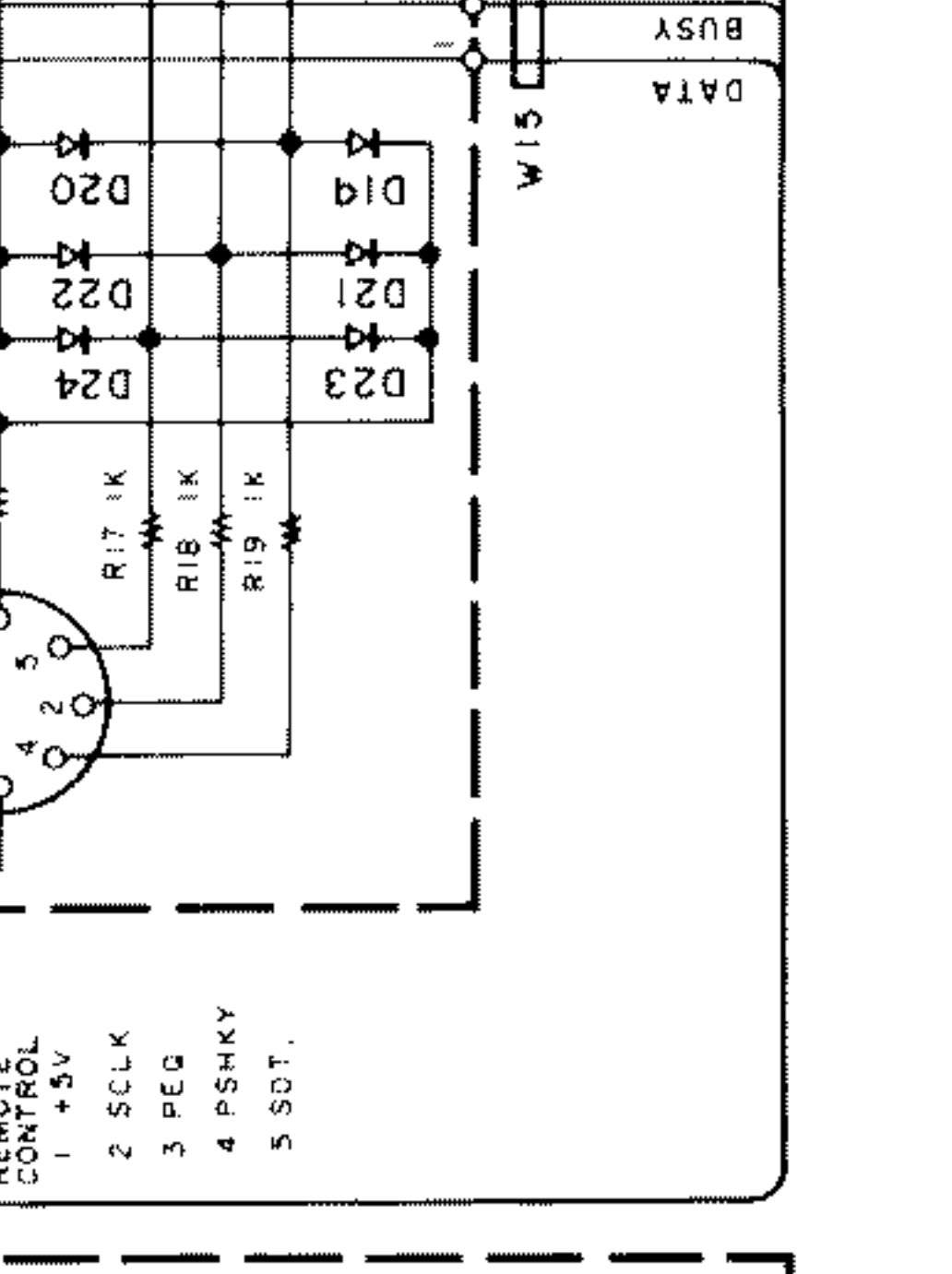
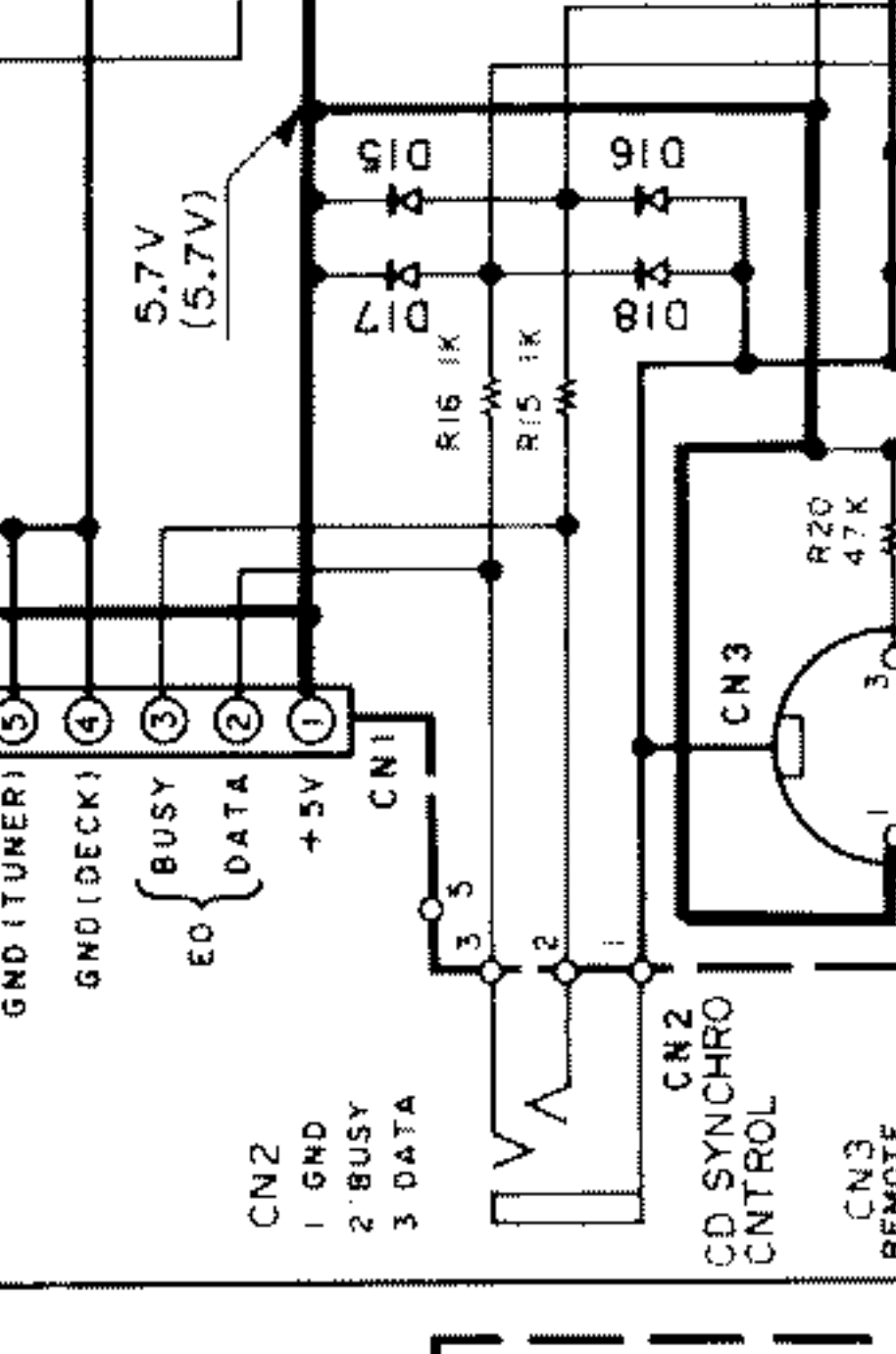
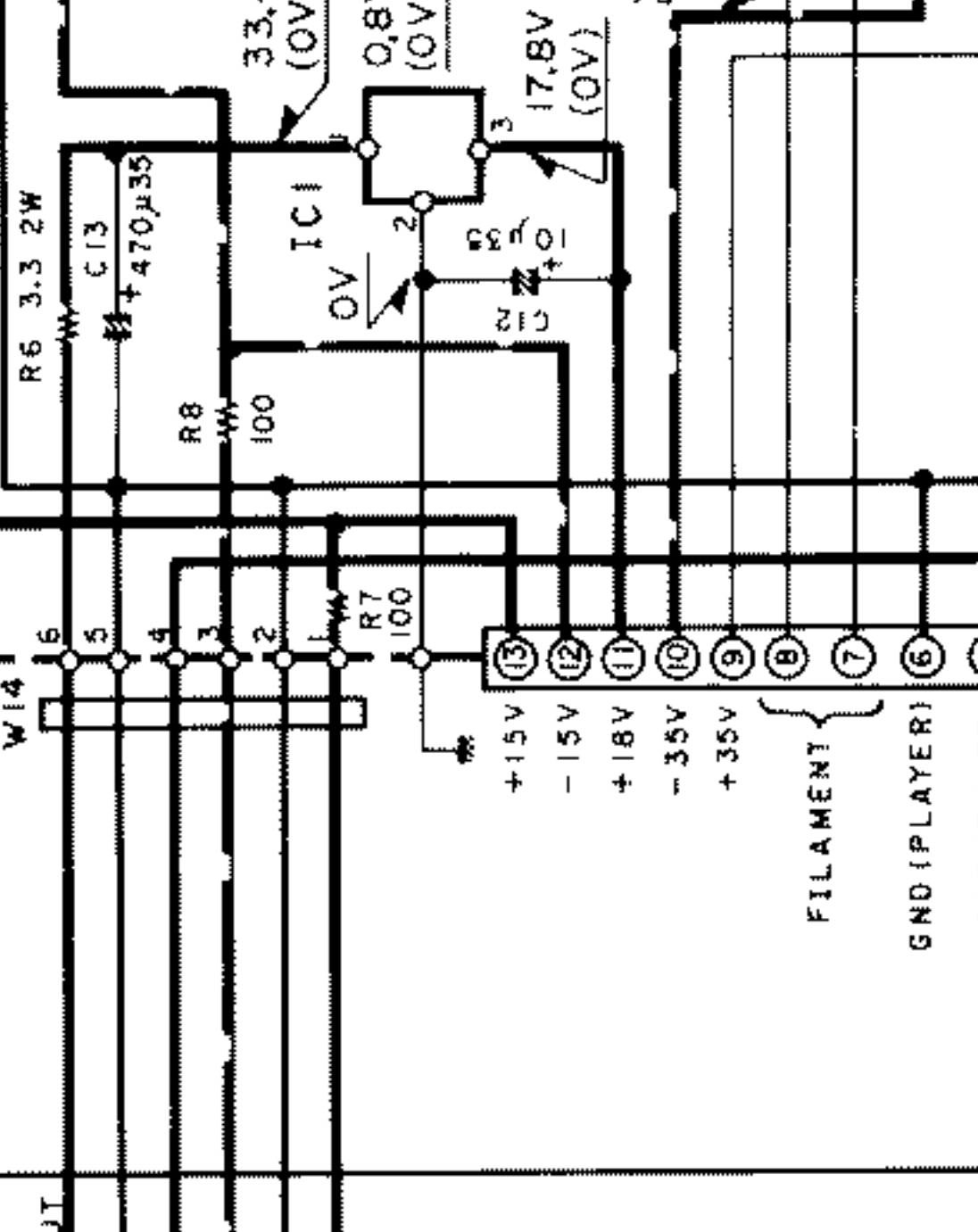
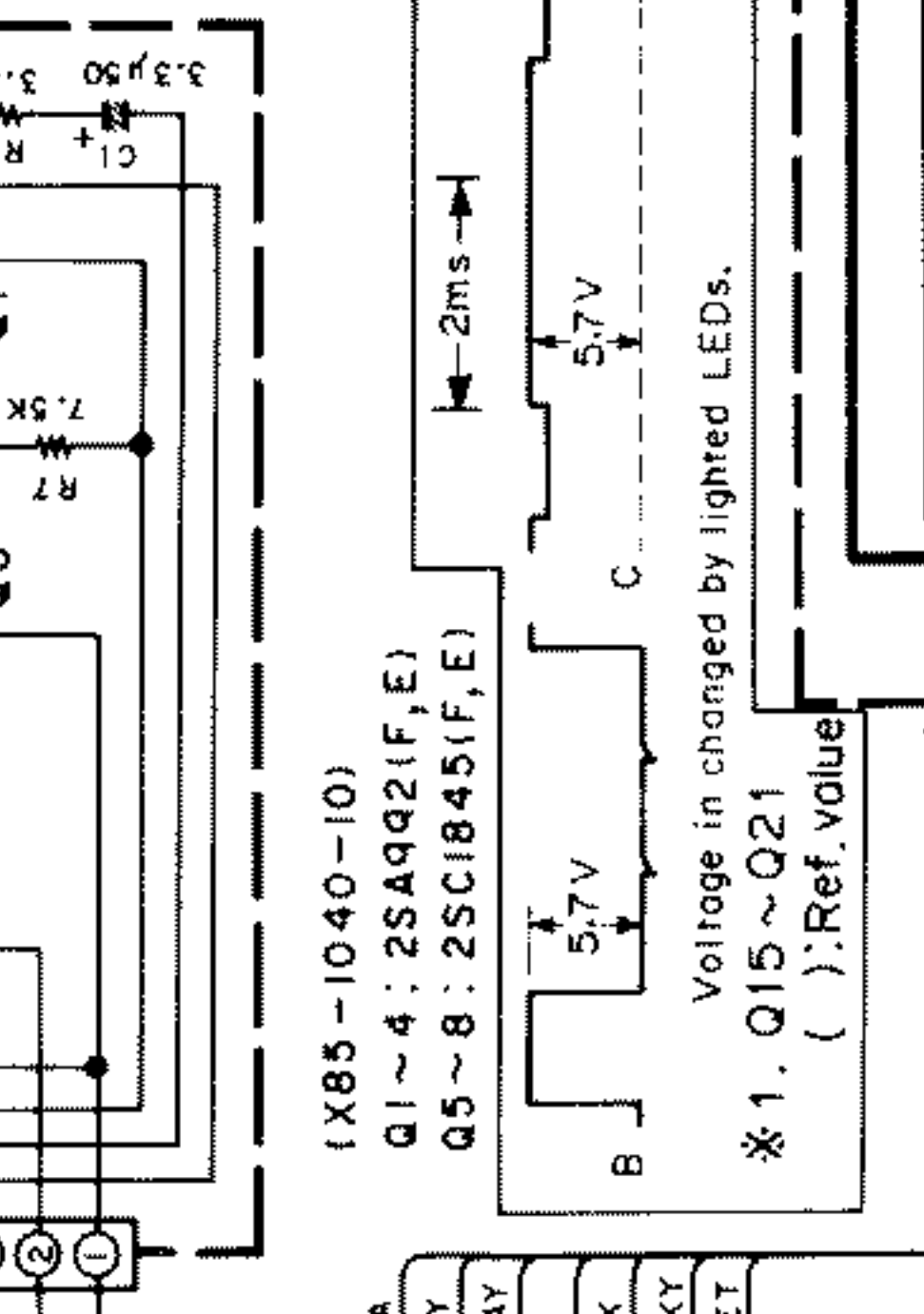
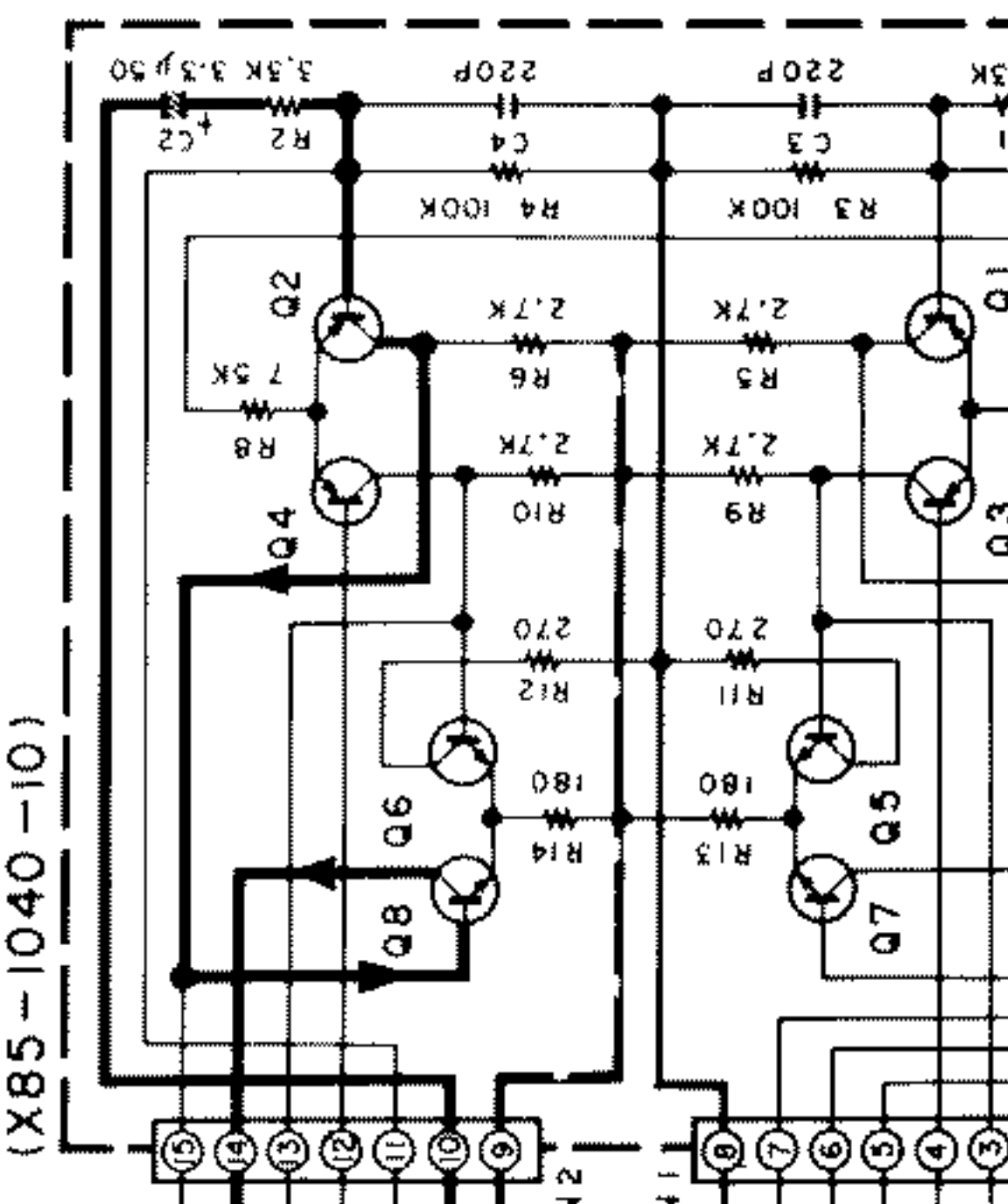

U.I.U.E.M TYPE
MIC JACK
HEADPHONES
SPEAKERS
ELECTRONIC VOLUME
TONE CONTROL CIRCUIT
MIC MIXING
BALANCE
SUPER BASS
TREBLE
BASS
ELECTRONIC VOLUME
POWER AMP
FINAL/DRIVER
LED DRIVERS
VIDEO SOURCE
TAPE SOURCE
TUNER SOURCE
VIDEO REC-A
TAPE REC-A
TUNER REC-A
VIDEO REC-B
TAPE REC-B
TUNER REC-B
VIDEO REC-C
TAPE REC-C
TUNER REC-C
VIDEO REC-D
TAPE REC-D
TUNER REC-D
VIDEO REC-E
TAPE REC-E
TUNER REC-E
VIDEO REC-F
TAPE REC-F
TUNER REC-F
VIDEO REC-G
TAPE REC-G
TUNER REC-G
VIDEO REC-H
TAPE REC-H
TUNER REC-H
VIDEO REC-I
TAPE REC-I
TUNER REC-I
VIDEO REC-J
TAPE REC-J
TUNER REC-J
VIDEO REC-K
TAPE REC-K
TUNER REC-K
VIDEO REC-L
TAPE REC-L
TUNER REC-L
VIDEO REC-M
TAPE REC-M
TUNER REC-M
VIDEO REC-N
TAPE REC-N
TUNER REC-N
VIDEO REC-O
TAPE REC-O
TUNER REC-O
VIDEO REC-P
TAPE REC-P
TUNER REC-P
VIDEO REC-Q
TAPE REC-Q
TUNER REC-Q
VIDEO REC-R
TAPE REC-R
TUNER REC-R
VIDEO REC-S
TAPE REC-S
TUNER REC-S
VIDEO REC-T
TAPE REC-T
TUNER REC-T
VIDEO REC-U
TAPE REC-U
TUNER REC-U
VIDEO REC-V
TAPE REC-V
TUNER REC-V
VIDEO REC-W
TAPE REC-W
TUNER REC-W
VIDEO REC-X
TAPE REC-X
TUNER REC-X
VIDEO REC-Y
TAPE REC-Y
TUNER REC-Y
VIDEO REC-Z
TAPE REC-Z
TUNER REC-Z

EXPLODED VIEW

A-7S A-7S

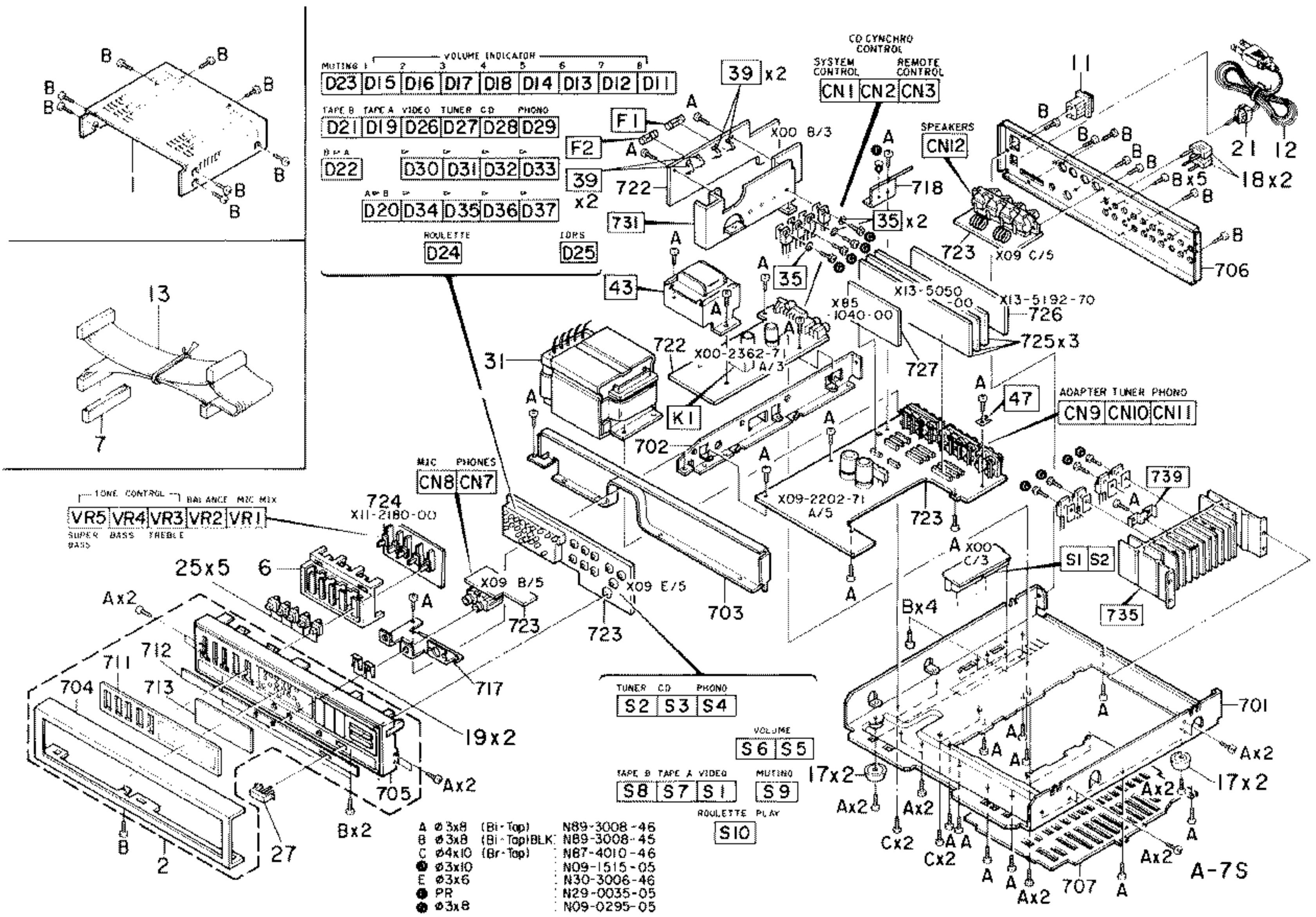

PARTS LIST

* New Parts
 Parts without Parts No. are not supplied.
 Les articles non mentionnés dans le Parts No. ne sont pas fournis.
 Teile ohne Parts No. werden nicht geliefert.

Ref. No.	Address	Parts No.	Description	Desti- nation	Re- marks
1	1A	A01-1441-01	METALLIC CABINET	UMUEE	
2	2A	A20-4723-02	PANEL ASSY	UMUEE	
2	2A	A20-4724-02	PANEL ASSY	UMUEE	
6	2A	B07-1416-02	ESCUTCHEON (TONE, BAL, MIC)	UMUEE	
7	1A	B09-0055-05	CAP	UMUEE	
		B46-0094-03	WARRANTY CARD	UMUEE	
		B46-0095-03	WARRANTY CARD	UMUEE	
		B46-0122-13	WARRANTY CARD	UMUEE	
		B46-0123-03	WARRANTY CARD	UMUEE	
		B50-5893-00	INSTRUCTION MANUAL (ENGLISH)	UMUEE	
		B50-5894-00	INSTRUCTION MANUAL (FRENCH)	UMUEE	
		B50-5895-00	INSTRUCTION MANUAL (SPANISH)	UMUEE	
		B50-5896-00	INSTRUCTION MANUAL (ARABIC)	UMUEE	
		B50-5897-00	INSTRUCTION MANUAL (ENGLISH)	UMUEE	
		B50-5898-00	INSTRUCTION MANUAL (G,D,I)	UMUEE	
		B58-0232-14	CAUTION CARD (PRE-SET 220V)	UMUEE	
		B58-0223-04	CAUTION CARD (PRE-SET 120V)	UMUEE	
		B58-0245-33	CAUTION CARD (FITZ)	UMUEE	
		B58-0375-04	CAUTION CARD	UMUEE	
		B58-0387-04	CAUTION CARD	UMUEE	
		B58-0398-04	CAUTION CARD	UMUEE	
		B59-0892-00	SERVICE DIRECTORY	UMUEE	
		E03-0036-05	AC BUTLET	UMUEE	
		E30-0459-05	AC POWER CORD	UMUEE	
		E30-0812-05	AC POWER CORD	UMUEE	
		E30-1416-05	AC POWER CORD	UMUEE	
		E30-1365-05	CORD WITH CONNECTOR	UMUEE	
		H01-5664-04	ITEM CARTON CASE	UMUEE	
		H01-7068-04	ITEM CARTON CASE	UMUEE	
		H10-1824-02	POLYSTYRENE FOAMED FIXTURE	UMUEE	
		H25-0148-04	PROTECTION BAG (110X230X0.07)	UMUEE	
		H25-0223-04	PROTECTION BAG (750X350)	UMUEE	
		H25-0232-04	PROTECTION BAG (235X350)	UMUEE	
		J02-0170-04	FAST PIN	UMUEE	
		J12-0894-05	JACK MOUNTING HARDWARE	UMUEE	
		J21-3326-05	POWER CORD BUSHING	UMUEE	
		J42-0083-05	WIRE BAND	UMUEE	
		J61-0307-05	WIRE BAND	UMUEE	
		K27-1533-04	KNB (BUTTON) TONE, BAL, MIC	UMUEE	
		K27-1536-04	KNB (BUTTON) ROULETTE	UMUEE	
		L01-6842-05	POWER TRANSFORMER	UMUEE	
		L01-6845-05	POWER TRANSFORMER	UMUEE	
		L01-6847-05	POWER TRANSFORMER	UMUEE	
		N09-1515-05	TAPPING SCREW (3X8)	UMUEE	
		N29-0035-05	PUSH RIVET (3.5X5.5)	UMUEE	
POWER SUPPLY (X00-2362-71)					
C1		C90-1391-05	ELECTRCS	UMUEE	
C2		C90-1386-05	EL FILTERS	UMUEE	
C3		C90-1382-05	ELECTRCS	UMUEE	
C4		C91-0769-05	CERAMIC	UMUEE	
C5		C91-0769-05	ELCTRCS	UMUEE	
C7		C904K113221M	ELECTRCS	UMUEE	

Parts with the exploded numbers larger than 700 are not supplied.

E: Scandinavia & Europe H: Audio Club K: USA P: Canada W: Europe
 T: England U: Far East (Hawaii)
 UE: AAFES(Europe) X: Australia M: Other Areas
 A indicates safety critical components.

PARTS LIST

* New Parts
Parts without Parts No. are not supplied.
Les articles non mentionnés dans le Parts No. ne sont pas fournis.
Teile ohne Parts No. werden nicht geliefert.

Ref. No. 参照番号	Address 位置	New Parts 新部品	Parts No. 部品番号	Description 部品名 / 規格	Desti- nation 向	Re- marks 備考
C8		*	CE04KW1H221M	ELECTR0 220UF 50WV		
C9		*	C90-1380-05	ELECTR0 2200UF 16WV		
C10 -12		*	C90-1382-05	ELECTR0 10UF 35WV		
C13		*	C90-1390-05	ELECTR0 330UF 50WV		
C14		*	CE04KW1H3R3M	ELECTR0 3.3UF 50WV		
C15		*	C90-1388-05	ELECTR0 2.2UF 50WV		
C16		*	C91-0647-05	CERAMIC 0.01UF F		
C19		*	CE04KW1H101M	ELECTR0 1.0UF 50WV		
CN1	1B	*	E08-1303-05	RECTANGULAR RECEPTACLE (13P)		
CN2	1B	*	E11-0152-05	MINIATURE PHONE JACK (3P) CD		
CN3	1C	*	E06-0519-05	CYLINDRICAL RECEPTACLE (REMOTE)		
F1	1B	*	F29-0014-05	INSULATING WASHER	TE	
F2	1B	*	F05-1623-05	FUSE (5EMK8) (250V T.L. 6A)	UMUE	
F3	1B	*	F05-3022-05	FUSE (250V 3A)	UMUE	
F4	1B	*	F05-1521-05	FUSE (250V 1.5A)	UMUE	
F5	1B	*	J13-0041-05	FUSE CLIP	UMUE	
F6	1B	*	J13-0054-05	FUSE CLIP	TE	
F7	1B	*	J61-0307-05	WIRE BAND	TE	
F8	1B	*	L01-6932-05	POWER TRANSFORMER	T	
F9	1B	*	L01-6935-05	POWER TRANSFORMER	UMUE	
F10	1B	*	L01-6937-05	POWER TRANSFORMER	E	
G	1B,2C	*	N09-0295-05	HEXAGON HEAD BOLT (M3X8,+)		
R1	1B	*	RD14AB2E681J	FL-PROOF RD 680 J 1/4W		
R3	1B	*	RS14DB3D271J	FL-PROOF RS 270 J 2W		
R6	1B	*	RS14DB3D5R6J	FL-PROOF RS 5.6 J 2W		
R7	1B	*	RD14AB2E101J	FL-PROOF RD 100 J 1/4W		
K1	1B	*	S51-1034-05	MAGNETIC RELAY		
S1	2C	*	S31-2083-05	SLIDE SWITCH (POWER TYPE)		
D1	1B	*	DSM1A1	DIODE		
D9	1B	*	RD24F(B)	ZENER DIODE		
D10	1B	*	RD16E(B)	ZENER DIODE		
D12	1B	*	1S5133	DIODE		
D14	1B	*	DSM1A1	DIODE		
D15 -24	1B	*	1S5133	DIODE		
IC1	1C	*	TA78D18AP	IC (VOLTAGE REGULATOR/ +18V)		
IC2	1C	*	AN7805*1	IC (VOLTAGE REGULATOR/ +5V)		
IC2	1C	*	TA7805AP*1	IC (VOLTAGE REGULATOR/ +5V)		
IC2	1C	*	UPE7805H*1	IC (VOLTAGE REGULATOR/ +5V)		
O1	1B	*	2SC2167	TRANSISTOR		
O3	1B	*	2SC1685(R,S)	TRANSISTOR		
O3	1B	*	2SC945(A) (O.P.)	TRANSISTOR		
O4	1B	*	2SA1127NC (R,S)	TRANSISTOR		
O4	1B	*	2SA733(A) (O.P.)	TRANSISTOR		
O5	1B	*	2SC2003(L,K)	TRANSISTOR		
O6	1B	*	2SC1685(R,S)	TRANSISTOR		
O6	1B	*	2SC945(A) (O.P.)	TRANSISTOR		
D11 -18	1A,1B	AUDIO (X09-2202-71)				
D19 -37	1A,1B		R30-0432-05	LED(LN31GCPH(0))		
			R30-0431-05	LED(LN21CPH)		
C1	1B	*	CC45FSL1H151J	CERAMIC 150PF J 35WV		
C15 -20	1B	*	CE04KW1V100M	ELECTR0 10UF 100V		

E: Scandinavia & Europe H: Audio Club K: USA P: Canada W: Europe
T: England U: PX (Far East, Hawaii)
UE: AAFES (Europe) X: Australia M: Other Areas

▲ indicates safety critical components.

PARTS LIST

* New Parts
Parts without Parts No. are not supplied.
Les articles non mentionnés dans le Parts No. ne sont pas fournis.
Teile ohne Parts No. werden nicht geliefert.

Ref. No. 参照番号	Address 位置	New Parts 新部品	Parts No. 部品番号	Description 部品名 / 規格	Desti- nation 向	Re- marks 備考
C21	1C	*	C90-1379-05	ELECTR0 33UF 16WV		
C23	1C	*	CC45FSL1H101J	CERAMIC 100PF J		
C25	1C	*	CC45FSL1H220J	CERAMIC 22PF J		
C27	1C	*	CC45FSL1H070D	CERAMIC 7.0PF D		
C29	1C	*	C90-1378-05	ELECTR0 22UF 16WV		
C31	1C	*	C91-0769-05	CERAMIC 0.01UF M		
C33	1C	*	CF92EV1H104J	ME 0.10UF J		
C33	1C	*	CK45FF1H473Z	CERAMIC 0.047UF Z		
C37	1C	*	CK45FF1H103Z	CERAMIC 0.010UF Z		
C41	1C	*	C90-1393-05	ELECTR0 3300UF 50WV		
C43	1C	*	CK45FE2H103P	CERAMIC 0.010UF P		
C45	1C	*	C90-1384-05	ELECTR0 47UF 50WV		
C46	1C	*	C90-1384-05	ELECTR0 47UF 50WV		
C47	1C	*	C90-1387-05	ELECTR0 1UF 50WV		
C48	1C	*	CE04KW1E470M	ELECTR0 47UF 25WV		
C49	1C	*	CE04KW1H101M	ELECTR0 100UF 50WV		
C50	1C	*	CK45FB1H561K	CERAMIC 560PF K		
C51	1C	*	CK45FF1H473Z	CERAMIC 0.047UF Z		
C52	1C	*	CC45FSL1H221J	CERAMIC 220PF J		
C53	1C	*	CK45FB1H222K	CERAMIC 2200PF K		
C53	1C	*	CK45FB1H561K	CERAMIC 560PF K		
C54	1C	*	CK45FB1H102K	CERAMIC 1000PF K		
C55 -58	1C	*	CE04KW1V100M	ELECTR0 10UF 35WV		
C59	1C	*	CE04KW0J471M	ELECTR0 470UF 6.3WV		
C61	1C	*	CE04KW1V100M	ELECTR0 10UF 35WV		
C62	1C	*	C90-1382-05	ELECTR0 10UF 35WV		
C67	1C	*	CC45FSL1H151J	CERAMIC 150PF J		
C69	1C	*	CC45FSL1H101J	CERAMIC 100PF J		
C76	1C	*	C91-0753-05	CERAMIC 470PF K		
CN7	1C	*	E23-0125-05	TERMINAL		
CN7	2B	*	E11-0160-05	PHONE JACK (7P)		
CN8	2B	*	E11-0159-05	PHONE JACK (3P)		
CN9	1C	*	E13-0814-05	PHONE JACK (8P)		
CN11	1C	*	E13-0497-05	PHONE JACK (4P)		
CN12	1C	*	E20-0455-05	SCREW TERMINAL BOARD (4P)		
L1	1C	*	L39-0085-05	PHASE-COMPENSATION COIL		
X1	1C	*	L78-0209-05	RESONATOR (4.194000MHZ)		
G	1B,2C	*	N09-0321-05	TAPPING SCREW (3X10)		
CP1	1B	*	R90-0187-05	MULTI-COMP 0.22X2 K 5W		
CP3	1B	*	R90-0278-05	MULTI-COMP 100KX7 J 1/6W		
R43 -46	1B	*	RD14AB2E331J	FL-PROOF RD 330 J 1/4W		
R47	1B	*	RS14DB3D100J	FL-PROOF RS 10 J 2W		
R49	1B	*	RD14AB2E2R2J	FL-PROOF RD 2.2 J 1/4W		
R53	1B	*	RS14DB3D271J	FL-PROOF RS 270 J 2W		
R54	1B	*	RS14KB3D271J	FL-PROOF RS 270 J 2W		
R55	1B	*	RS14DB3D182J	FL-PROOF RS 1.8K J 2W		
R59	1B	*	RD14AB2E20J	FL-PROOF RD 82 J 1/4W		
R60	1B	*	RS14DB3D5R6J	FL-PROOF RS 5.6 J 2W		
S1	1B	*	S40-1064-05	PUSH SWITCH		
D1	1B	*	1S5133	DIODE		
D3 -6	1B	*	GF20DL	DIODE		
D7	1B	*	DSM1A1	DIODE		

E: Scandinavia & Europe H: Audio Club K: USA P: Canada W: Europe
T: England U: PX (Far East, Hawaii)
UE: AAFES (Europe) X: Australia M: Other Areas

▲ indicates safety critical components.

PARTS LIST

* New Parts
Parts without Parts No. are not supplied.
Les articles non mentionnés dans le Parts No. ne sont pas fournis.
Teile ohne Parts No. werden nicht geliefert.

Ref. No. 参照番号	Address 位	Parts No. 部品番号	Description 部品名 / 規格	Desti- nation 向	Re- marks 備考
D8		152076A	DIODE		
D9		153133	DIODE		
D38 -48		153133	DIODE		
IC1		ANG556	IC(OP AMP X2)		
IC2	*	UPD7508HC-049	IC(MICROPROCESSOR)		
Q1 ,2		25D1302(S)	TRANSISTOR		
Q3 ,4		25C745(A)(Q)	TRANSISTOR		
Q5 ,6		25C3244(D,E)	TRANSISTOR		
Q7 ,8		25A1284(D,E)	TRANSISTOR		
Q9 ,10		25C2577	TRANSISTOR		
Q11 ,12		25A1102	TRANSISTOR		
Q13		25C1685(R,S)	TRANSISTOR		
Q13		25C745(A)(Q,P)	TRANSISTOR		
Q14 -21		25A1127NC(R,S)	TRANSISTOR		
Q14 -21		25A733(A)(Q,P)	TRANSISTOR		
Q22 -25		25C2003(L,K)	TRANSISTOR		
PHONE (X11-2180-00)					
C1 ,2		CE04KW1V100M	ELECTRO		35WV
C3 -6		CE04KW1HR47M	ELECTRO		0.47UF 50WV
C7 -10		CE04KW1HR2R2M	ELECTRO		2.2UF 50WV
C11 -14		CF92FV1H473J	MF		0.047UF J
C15 -18		CE04KW1HR2R2M	ELECTRO		2.2UF 50WV
C19 ,20		CK45FB1H102K	CERAMIC		1000PF K
C21 -24		CE04KW1HR47M	ELECTRO		4.7UF 50WV
C25 ,26		CE04KW1H010M	ELECTRO		1.0UF 50WV
C27 ,28		CC45FSL1H221J	CERAMIC		220PF J
C29 ,30		CE04KW1V100M	ELECTRO		10UF 35WV
C32		CC45FSL1H101J	CERAMIC		100PF J
VR1	2A	R13-5071-05	POTENTIOMETER(100KX2)		MIC
VR2	2A	R13-5070-05	POTENTIOMETER(200K)		BALANCE
VR3 -5	2A	R13-3026-05	POTENTIOMETER(10K)		TONE
IC1		TC9176P	IC(2CH ELECTRONIC VOLUME)		
IC2	*	NJM2068D-D	IC(OP AMP X2)		
IC2	*	UPC4570C	IC(OP AMP X2)		
SWITCH (X13-5050-00)					
C1 -4		C91-0769-05	CERAMIC		0.01UF M
IC1	*	LC7820	IC(ELECTRO CONTRL SWITCH)		
SUB (X13-5192-70)					
C1 ,2		CE04KW1HR47M	ELECTRO		0.47UF 50WV
C3 ,4		CK45FB1H471K	CERAMIC		470PF K
C5 ,6		CE04KW1HR47M	ELECTRO		0.47UF 50WV
C7 ,8		CK45FB1H471K	CERAMIC		470PF K
C9 ,10		CE04KW1HR47M	ELECTRO		0.47UF 50WV
C11 ,12		CK45FB1H471K	CERAMIC		470PF K
C13		CE04KW1HR47M	ELECTRO		0.47UF 50WV
C14	*	CE04KW1HR47M	ELECTRO		0.47UF 50WV
C15 ,16		CK45FB1H471K	CERAMIC		470PF K
C17		CE04KW1V100M	ELECTRO		10UF 35WV
C18		CE04KW1V100M	ELECTRO		10UF 35WV
C19 ,20		CE04KW1HR1M	ELECTRO		0.1UF 50WV
C21 ,22		CK45FB1H471K	CERAMIC		470PF K
C23 ,24		CE04KW1H010M	ELECTRO		1.0UF 50WV

E: Scandinavia & Europe H: Audio Club K: USA P: Canada W: Europe
T: England U: PX(Far East Hawaii)
UE: AAFES(Europe) X: Australia M: Other Areas
▲ indicates safety critical components.

PARTS LIST

* New Parts
Parts without Parts No. are not supplied.
Les articles non mentionnés dans le Parts No. ne sont pas fournis.
Teile ohne Parts No. werden nicht geliefert.

Ref. No. 参照番号	Address 位	Parts No. 部品番号	Description 部品名 / 規格	Desti- nation 向	Re- marks 備考
C25 ,26		CE04KW1H010M	ELECTRO		0.1UF 50WV
C27 ,28		CK45FB1H471K	CERAMIC		470PF K
C29 ,30		CE04KW1H010M	ELECTRO		1.0UF 50WV
D1 -16		153133	DIODE		
D1 -16		155176	DIODE		
Q1 -12		25C1845(F,E)	TRANSISTOR		
PRE AMP (X85-1040-10)					
C1 ,2		CE04FW1H3R3M	ELECTRO		3.3UF 50WV
C3 ,4		CC45FSL1H221J	CERAMIC		220PF J
R11 ,12	*	RD14AB2E271J	FL-PROOF RD		270 J 1/4W
R13 ,14		RD14AB2E181J	FL-PROOF RD		180 J 1/4W
Q1 -4		25A992(F,E)	TRANSISTOR		
Q5 -8		25C1845(F,E)	TRANSISTOR		

E: Scandinavia & Europe H: Audio Club K: USA P: Canada W: Europe
T: England U: PX(Far East Hawaii)
UE: AAFES(Europe) X: Australia M: Other Areas
▲ indicates safety critical components.

SPECIFICATIONS

CAUTION

AUDIO SECTION [OVERALL CHARACTERISTICS] TUNER, TAPE to SPKR (Partially PHONO to SPKR)

Continuous Average Power Output

38 watts* per channel minimum RMS, both channels driven, at 8 ohms from 30 Hz to 20,000 Hz with no more than 0.06% total harmonic distortion.

Maximum continuous output power (IEC)

from 60 Hz to 12,500 Hz, 0.7% THD

at 8 ohms 43W + 43W

Total Harmonic Distortion (30 Hz to 20,000 Hz)

AUX → Speaker (8 Ω)/POWER in → Speaker (8 Ω)

At rated output 0.06%

At 1/2 rated output 0.04%*

Intermodulation Distortion

(60 Hz : 7 kHz = 4 : 1) 0.04% at rated output into 8 ohms

Frequency Response

Overall [AUX → SPKR] 10 Hz to 40 kHz, ±3dB

Signal-to-Noise Ratio (HF-A) at rated output

Tuner, AUX, Tape play 93 dB

Mic 64 dB

Signal-to-Noise ratio at unweighted, 50 mW output

Tuner, AUX, Tape play 57 dB (DIN)

Output Level/Impedance

Tape REC (Pin) 150 mV/1 k ohms

* 20 Hz~20,000 Hz

Tone Control

Super Bass ± 10 dB at 30 Hz

Bass ± 10 dB at 200 Hz

Treble ± 10 dB at 10 kHz

Damping Factor 50, at 50 Hz

Input Sensitivity/Impedance

Phono MM 150 mV/47 k ohms

Tuner, AUX, Tape play 150 mV/47 k ohms

Mic 1.3 mV/47 k ohms

Channel Separation (DIN) at 1,000 Hz

AUX (Terminated with 47 k ohms

+ 250 pF) 60 dB

General

Power Requirement AC 220 V, 50 Hz

Power Consumption (IEC) 200 W

Dimensions (W x H x D) 340 x 84 x 361.5 mm

Weight Net 6.6 kg

Note :

We follow a policy of continuous advancements in developments. For this reason specifications may be changed without notice.

PRECAUTIONS FOR REPAIR

MIDI M-7S, M-5S has a power supply unit only in amplifier A-7S and power transformers are not incorporated in other sets (tuner, cassette tape deck, etc.). At the occasion of repair to a set that is other than the amplifier, use the power supply unit of amplifier A-7S, and supply power to another set using a system control connection cord.

The combination of MIDI M-7S, M-5S is as follows. When a repair to MIDI M-7S, M-5S is requested, be sure to advise the customer to ship together with amplifier A-7S.

System name	Amplifier	Tuner	Cassette tape deck	Turntable
MIDI M-5S	A-7S	T-5S/T-5LS	X-5WS	P-5S
MIDI M-7S	A-7S	T-5S/T-5LS	X-7WS	P-7S

Note :
Component and circuitry are subject to modification to insure best operation under differing local conditions. This manual is based on the Europe (E) standard, and provides information on regional circuit modification through use of alternate schematic diagrams, and information on regional component variations through use of parts list.

TRIO-KENWOOD CORPORATION

Shinjogu Shibuya Building, 17-5, 2-chome Shibuya, Shibuya-ku, Tokyo 150, Japan
KENWOOD ELECTRONICS
 DIVISION OF KENWOOD U.S.A. CORPORATION
 1315 E. Watsoncenter Rd., Carson, California 90745, U.S.A.
 75 Seaview Drive, Secaucus, New Jersey 07094, U.S.A.
TRIO-KENWOOD CANADA INC.
 1070 Jaysan Court, Mississauga, Ontario, Canada L4W 2V5
TRIO-KENWOOD ELECTRONICS, NV.
 Leuvensesteenweg 504 B-1930 Zaventem, Belgium
TRIO-KENWOOD ELECTRONICS GmbH
 Fernbrücker Str. 15, 6056 Heusenstamm, West Germany
TRIO-KENWOOD FRANCE S.A.
 5, Boulevard Ney, 75018 Paris, France
TRIO-KENWOOD (AUSTRALIA) PTY LTD. (INCORPORATED IN NSW)
 4E Woodcock Place, Lane Cove, N.S.W. 2066, Australia
KENWOOD & LEE ELECTRONICS, LTD.
 Wang Kee Building, 5th Floor, 34-37, Connaught Road, Central, Hong Kong